

URBAN  
*Bonfire*<sup>®</sup>  
URBAN



YOUR KITCHEN OUTDOORS



## Contents

### ABOUT US

The Urban Bonfire Framework	4
-----------------------------	---

### INSPIRATIONS

A Modern Farmhouse in Mulmur, Ontario	7
A Rustic Outdoor Pavilion in Puslinch, Ontario	12
A Hideaway in Sechelt, British Columbia	17
An Outdoor Kitchen Fit for a Chef in San Diego, California	19
A Thoughtful Outdoor Space in Palm Desert, California	20
A Home in the Heart of Montréal, Quebec	22
A Peaceful Backyard in Los Angeles, California	25

### CUSTOMIZATION | FINISHES | TECHNICAL FEATURES

Engineered for Life Outdoors	29
Finishes	30
Accessories	32
The Classics Collection	34

### PRODUCT INDEX

Cabinetry	38
Accessories	42
Finished Panels	44
Gardening	45
Others	48
Appliance Kits	50
Cabinet Specifications	52
Sample Kit	55
Professional Partner Program	56
Urban Bonfire Atelier	57

# THE URBAN BONFIRE Framework

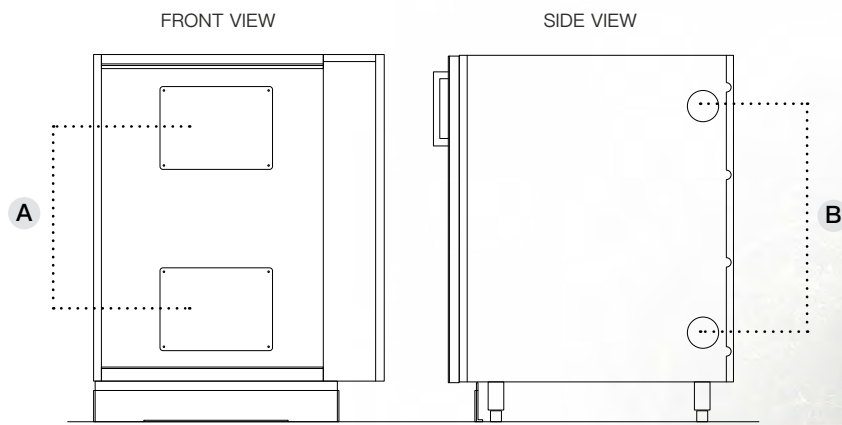

## Access Panels A and Conduits Points B

Designed for easy access and connections to services such as electrical, gas and plumbing.

## NACRAE™ Finishes

Super durable NACRAE™ powder coated finish with anti-microbial protection included on all cabinets, planters and accessories surfaces.



## Universal Track System

Accessories can be added or moved to maximize efficiency, functionality and full cabinet usage. Mix and match drawers, shelves, refuse and more...



## Construction

Non-combustible marine grade aluminum and outdoor grade 304 stainless steel hardware.



## Integrated Backsplash System

Extruded aluminum with NACRAE™ powder coating.

Matching Clip-in Planters and other accessories available.



## Compatibility

Custom trim kits for compatibility with most major outdoor appliance brands and models. Ready to receive Dekton® and other outdoor-rated countertop materials.

## A Solid Foundation

Commercial-grade 304 stainless leveling legs on every cabinet. Self-leveling toe kick that adapts to slope and outdoor site conditions.



## A Modern Farmhouse in Mulmur, Ontario

This modern farmhouse-style outdoor pavilion is the ultimate outdoor living and entertaining space. Designer Lisa Aiken, of Terra Firma Design, worked with the homeowners to renovate the property both inside and out. “The outdoor space was completely reconfigured with a wrap-around porch connecting all the various areas within the farmhouse,” she explains. The porch opens onto an expansive outdoor pavilion, with a large pool and lounging area, a full chef’s kitchen and a spacious dining and living area, complete with a stone fireplace.

*“I provide the project’s dimensions and needs, the gorgeous color, the handles, and the inserts I want, and they take care of the rest. What could be better? I haven’t looked back since! The entire process from start to finish was made easy for me as a designer and easy for the contractor to install.”*

— Lisa Aiken, Terra Firma Design

---

NACRAE™ Powder Coated Finish: Onyx

Handle Model: Stainless Steel

Photography Credit: Rob Holowka, Birdhouse Media





## A Rustic Outdoor Pavilion in Puslinch, Ontario

*“The stone cladding around the cabinets and along the back wall are a perfect complement to the warm taupe of Urban Bonfire’s Clay finish. The dark iron fixtures are reflected in the Dekton Radium countertops. Frontier Design and Build’s solid wood shelves and timber light fixtures create a textural counterpoint to Urban Bonfire’s streamlined design. It all works beautifully together!”*

— Aileen Brown, Paragon Kitchens

---

NACRAE™ Powder Coated Finish: Clay  
Handle Model: Bauhaus in Black Bronze  
Photography Credit: Stuart Visuals









## A Hideaway in Sechelt, British Columbia

This peaceful outdoor space in Sechelt, British Columbia by Emerge Design is a home away from home for a young and busy family. Dark and naturally light tones marry to create a dynamic yet comfortable space in which to relax and unwind.



NACRAE™ Powder Coated Finish: Onyx  
Handle Model: Stainless Steel  
Photography Credit: Kevin Jamieson, KRJ Photography



## An Outdoor Kitchen Fit for a Chef in San Diego, California

*“My outdoor kitchen has the functionality to be able to withstand living by the beach in San Diego and being outside for years and years. It also has the functionality of the built-in drawers and shelves, as well as pull-out trash and recycling, just like an indoor kitchen does. Working with the Urban Bonfire in-house design team was great. They were able to use the specs that I gave them and design a beautiful kitchen that was both functional and gorgeous.”*

— Whitney Bond, homeowner



NACRAE™ Powder Coated Finish: Anthracite  
Handle Model: Bauhaus in White Bronze  
Photography Credit: Hugo Landa Garcia

## A Thoughtful Outdoor Space in Palm Desert, California

With expansive views of Joshua Tree National Park, this outdoor cooking and entertaining space was designed for a true cooking enthusiast. The homeowner, Dale Seiden, has a background in high-end custom commercial kitchen design and wanted to create the ultimate outdoor entertaining space in a small footprint. His challenge was keeping the space functional, without overcrowding it with appliances.



*“This is an amazing company: the quality of the product, workmanship and ease of installation. The Urban Bonfire team is easy to work with. They’re responsive, proactive and make the experience the best there is, period. I love the product because of the company’s DNA.”*

— Dale Seiden, homeowner



NACRAE™ Powder Coated Finish: Pewter  
Handle Model: Stainless Steel  
Photography Credit: Hugo Landa Garcia

## A Home in the Heart of Montréal, Quebec

“We live in an urban neighborhood with a small backyard and we wanted to maximize our space for outdoor living. The amazing designers at Urban Bonfire got it right the first time. The design fit the space perfectly and corresponded exactly to what we needed.”

— Micol and Charles, homeowners

Our Slatwall Backsplash system and matching Clip-in Planters allow for a vertical use of space in this urban backyard.

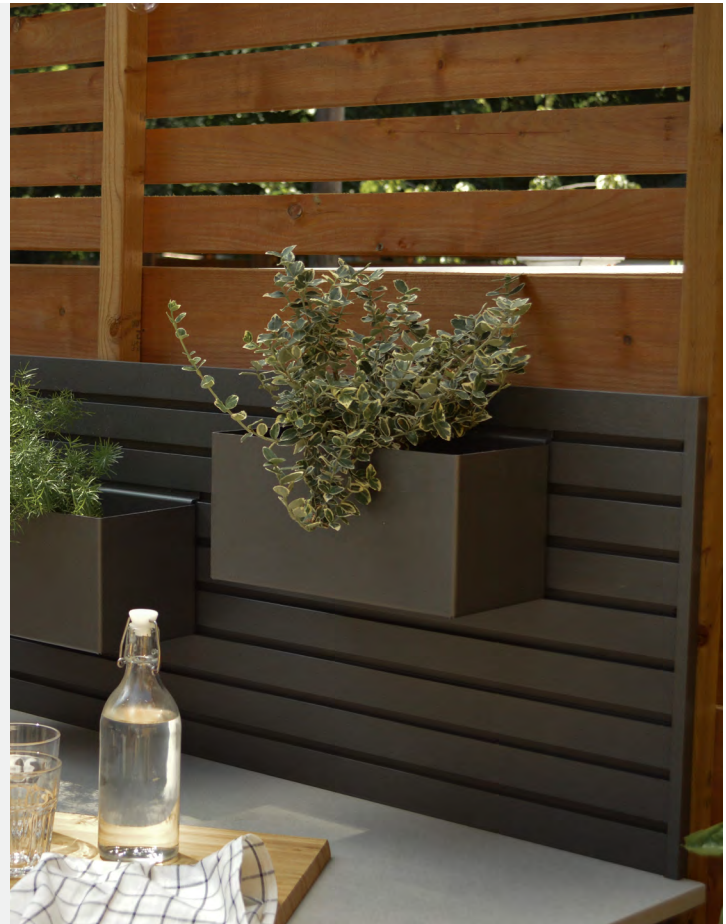

NACRAË™ Powder Coated Finish: Anthracite  
Handle Model: Stainless Steel  
Photography Credit: Mélanie Bellemare



## A Peaceful Backyard in Los Angeles, California

As part of a whole house remodel, actress Katee Sackhoff and her husband wanted a beautiful and functional outdoor entertainment space. Their outdoor kitchen includes generous functional storage space with a pull-out storage peg system on the far left, a pull-out garbage and recycling module between the Big Green Egg and the fridge, and an open shelving cabinet with Ipe wood slats on the far right, ideal for housing glasses and plates when entertaining.

*“Urban Bonfire’s design team was so wonderful, sending us detailed preliminary design images and measurements so that we could get everything just right. And when it showed up, it fit PERFECTLY in the space. My husband was able to assemble the whole kitchen himself in one day and he said he was blown away by how lightweight but solid the aluminum cabinetry was.”*

— Katee Sackhoff, homeowner



The kitchen is framed by two matching Cube Planters and our Slatwall Backsplash with Clip-in Planters housing succulents.



# CUSTOMIZATION FINISHES TECHNICAL FEATURES

## Engineered for Life Outdoors

Our rugged cabinetry is designed, manufactured and tested in North America, and carefully assembled, inspected and packaged by experienced craftspeople.



### Marine Grade Aluminum

Our marine grade aluminum is twice as thick as most stainless steel cabinetry on the market, yet lighter in weight. Aluminum is easy to transport and cooperates well during installations. It is the ideal material for extreme climates (snow, ice, salt water, humidity) and provides long-term quality.

Urban Bonfire's products and accessories are powder coated with our proprietary **NACRAE™ finish**. Inspired by the beauty, strength and resilience of mother of pearl, each finish is crafted with a micro-textured formulation that preserves and protects its beauty in all climates, creating a stable depth of color in any outdoor environment.

Now with revolutionary, all-natural, anti-microbial protection, our NACRAE™ finish is a standard feature on all Urban Bonfire products and accessories.



#### Durable

4-season formulation that resists scratches, fading and stains even in harsh climates.



#### Anti-microbial

Integrated all-natural, anti-microbial properties for maximum safety and freshness.



#### FDA-Approved

Environmentally sustainable material and process.



#### Specialty Colors

A collection developed in collaboration with iconic designers.



### 304 Outdoor Grade Stainless Steel

We use outdoor grade 304 stainless steel for our door slides, hinges, pulls and leveling legs.

# NACRAE™ Powder Coated Finishes



Compatible with our Classics Collection.



## Anthracite (AN)

Modern dark gray with slate undertones. Elevates contemporary and outdoor urban environments.

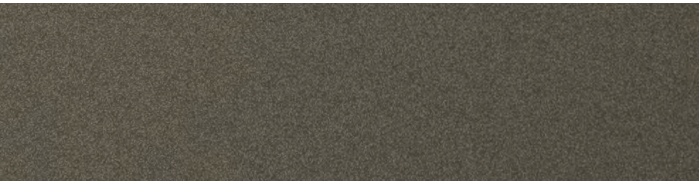

## Artesan (AR)

Dark gray finish with a warm bronze undertone. Designed to accent wood and natural limestone while creating a welcome contrast through its depth of tone.

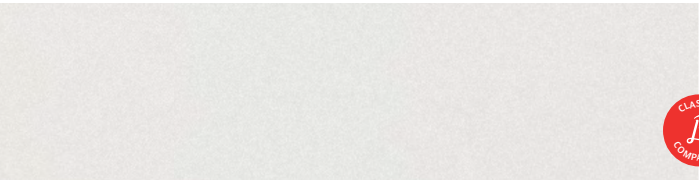

## Chantilly (CH)

This crisp white works in almost any outdoor setting. Reflecting tones of silk and clean linen.

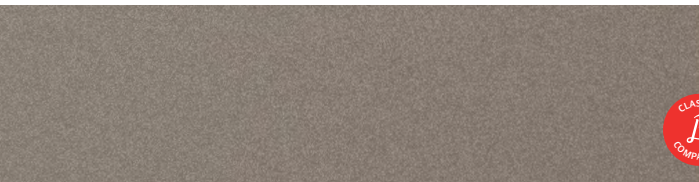

## Clay (CL)

An elegant and versatile rich beige. Enhances the mood and atmosphere of any classic outdoor living space.

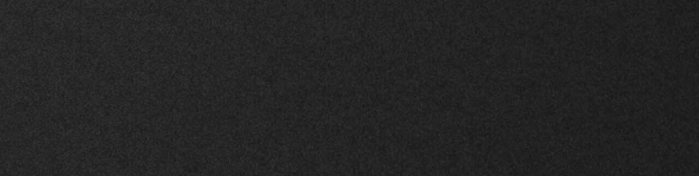

## Onyx (ON)

Deep, dark black that is sure to create a standout piece in any environment.

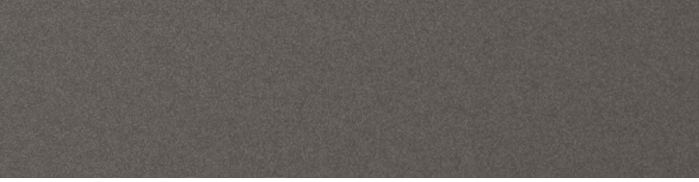

## Pewter (PE)

Warm dark gray with bronze undertones. Adds a refined touch to any outdoor environment.

## Compatible with Outdoor-Rated Countertops

Our custom-made trim kits enable our cabinetry to accommodate surfaces of various thicknesses. For more information on countertop options, please speak with one of our in-house designers.

## Handle Options



316 STAINLESS STEEL



BAUHAUS (3312)



URBAN (337)



PULL (341)

### STANDARD INCLUSION

## 316 Stainless Steel

Each cabinet includes a premium outdoor grade 316 stainless steel handle.

For added resistance against harsh climates, and for greater personalization, these handles are also available with NACRAE™ powder coated finishes as an upgrade.

### Available finishes

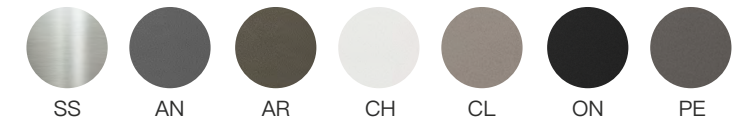

### UPGRADE OPTIONS

## “Living Finish” Solid Bronze

These handles are constructed from highly durable solid bronze. They include a “living finish” that protects them from excessive corrosion and allows them to age naturally in their environment. Like all bronze products, these handles gain character as they weather and age with expected changes in tone.

Contact us for available finishes.

Colors digitally rendered. Actual products may vary.





## Accessories

More than a cabinet, this is a functional and adaptable storage system. Choose from a selection of accessories in order to maximize the functionality of your outdoor kitchen. Using our Universal Track System, these accessories can always be adapted to suit your specific needs.



Activate your outdoor space with our selection of gardening and lifestyle products. Made of thick marine grade aluminum, our planters are available in our collection of NACRAË™ powder coated finishes and a wide array of shapes and sizes.

Our Slatwall Backsplash is designed to be both aesthetically pleasing and functional. Made of 6" tall panels, it can be configured to various heights and lengths and can house our Clip-in Planters and other accessories.





## The Urban Bonfire Classics Collection

The Urban Bonfire Classics Collection offers a selection of our most popular outdoor kitchen configurations, colors and accessories. Designed to fit various spaces and entertaining needs, our collection features various functional storage options, sinks and faucets, and is compatible with numerous industry-leading appliance brands.

Our selection of more than fifty configurations allows you to choose a kitchen that suits your needs and your space.

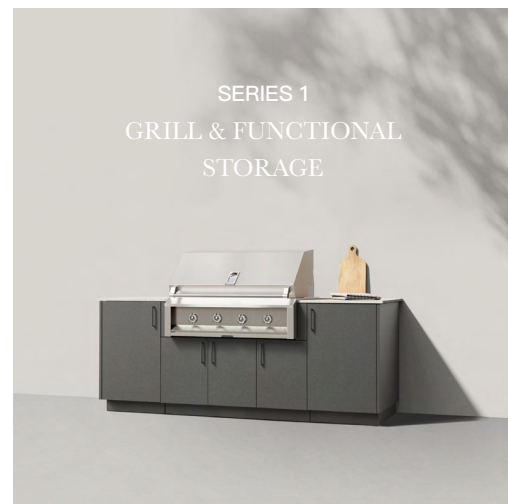

Available NACRAE™  
Powder Coated Finishes



### Countertop Ready

Our specially engineered packaging allows the kitchen and countertop to ship together safely while our industry first mechanical installation process (developed in partnership with Cosentino) ensures efficient installation of your Dekton countertop every time.

Premium 2 cm Dekton® Countertops are available in Danae and Keon finishes and can be added to all Classics models.



DANAE

KEON

# PRODUCT INDEX

# Cabinetry

## Grill Base Cabinets



Thick marine grade aluminum construction. All outdoor grade 304 stainless steel hardware. Includes self-leveling toe kick, choice of powder coating and solid 316 stainless steel round handles. Grill base cabinets are specified 4" – 6" larger than the grill specified.

Width	SKU
36"	A-GB36
42"	A-GB42
48"	A-GB48
62"	A-GB62

## Side & Power Burner Base Cabinets



Thick marine grade aluminum construction. All outdoor grade 304 stainless steel hardware. Includes self-leveling toe kick, choice of powder coating and solid 316 stainless steel round handles. Single, dual and power burner cabinets are specified 6" larger than the grill specified.

Width	SKU
21"	A-BB21
30"	A-BB30

[View this product](#)

## Kamado Cabinets



Kamado style smoker cabinet. Thick marine grade aluminum construction. Includes self-leveling toe kick and choice of powder coating. A piece of countertop should be planned underneath the base of the appliance and Kamado "feet" should be used (not provided by Urban Bonfire).

Width	SKU
27" Closed	A-BE27-C
27" Open	A-BE27-O
33"	A-BE33

[View this product](#)

## Utility Cabinets



Utility base storage with Universal Track Keyhole System for accessories. Thick marine grade aluminum construction. All outdoor grade 304 stainless steel hardware. Includes self-leveling toe kick, choice of powder coating and solid 316 stainless steel round handles.

Every Utility Cabinet includes our Universal Track System to allow for easy customization and maximize functionality and full cabinet usage.

Width	SKU
12"	A-BF12
18"	A-BF18
21"	A-BF21
24"	A-BF24
30"	A-BF30

[View this product](#)

## Large Utility Cabinets



Utility base storage with Universal Track Keyhole System for accessories. Thick marine grade aluminum construction. All outdoor grade 304 stainless steel hardware. Includes self-leveling toe kick, choice of powder coating and solid 316 stainless steel round handles.

Every Utility Cabinet includes our Universal Track System to allow for easy customization and maximize functionality and full cabinet usage.

Width	SKU
36"	A-BF36
42"	A-BF42
48"	A-BF48

[View this product](#)

### Storage Cabinet with Single Drawer



Storage cabinet equipped with single drawer, stainless steel soft-close drawer slides and centered shelf. Thick marine grade aluminum construction. All outdoor grade 304 stainless steel hardware. Includes self-leveling toe kick, choice of powder coating and solid 316 stainless steel round handles.

Width	SKU
18"	A-BR18
21"	A-BR21
24"	A-BR24

[View this product](#)

### Pull-out Refuse Cabinet with Single Drawer



Pull-out refuse cabinet with single top drawer, equipped with stainless steel soft-close slides and two (2) heavy duty plastic refuse bins. Thick marine grade aluminum construction. All outdoor grade 304 stainless steel hardware. Includes self-leveling toe kick, choice of powder coating and solid 316 stainless steel round handles.

Width	SKU
18"	A-BG18
21"	A-BG21
24"	A-BG24

[View this product](#)

### Sink Cabinets



Utility base storage cabinet. Thick marine grade aluminum construction. All outdoor grade 304 stainless steel hardware. Includes self-leveling toe kick, choice of powder coating and solid 316 stainless steel round handles.

Width	SKU
12"	A-BF12-S
18"	A-BF18-S
21"	A-BF21-S
24"	A-BF24-S
30"	A-BF30-S
36"	A-BF36-S
42"	A-BF42-S
48"	A-BF48-S

[View this product](#)

### Flush Mount Drawer Cabinet



Flush mount drawer cabinet with full depth heavy duty drawer (3). Thick marine grade aluminum construction. All outdoor grade 304 stainless steel hardware. Includes self-leveling toe kick, choice of powder coating and solid 316 stainless steel round handles.

Width	SKU
21"	A-BD21

[View this product](#)

### Open Shelving Cabinets



Flexible storage for cooking and entertaining needs. Ideal for platters, glasses and more. Thick marine grade aluminum construction. Includes self-leveling toe kick, choice of oiled natural IPE wood or powder coated marine grade aluminum internal slats.

Width	SKU
24"	A-BO24-M
24"	A-BO24-W
27"	A-BO27

[View this product](#)

### Spacer Modules



4" module designed for added structural support of countertop if/where applicable. Thick marine grade aluminum construction. Includes self-leveling toe kick and choice of powder coating. Available with or without cut-out for waterproof plug box and cover (supplied and installed by local electrician).

Width	SKU
4"	A-BF4
4"	A-BF4-C

[View this product](#)

# Accessories

## Pull-out Storage Peg System



Shown here with A-DR12.

Thick marine grade aluminum construction. All outdoor grade 304 stainless steel hardware. Includes choice of powder coating.

Width	SKU
12"	A-PEG12

[View this product](#)

## Full Depth Adjustable Height Shelf



Thick marine grade aluminum construction. All outdoor grade 304 stainless steel hardware. Includes choice of powder coating. Up to two shelves per cabinet.

Width	SKU
12"	A-SHELF12
18"	A-SHELF18
21"	A-SHELF21
24"	A-SHELF24
30"	A-SHELF30
36"	A-SHELF36
42"	A-SHELF42
48"	A-SHELF48

[View this product](#)

## Heavy Duty Retractable Drawer



Thick marine grade aluminum construction. All outdoor grade 304 stainless steel hardware. Includes choice of powder coating. Up to three drawers per cabinet.

Width	SKU
12"	A-DR12
18"	A-DR18
21"	A-DR21
24"	A-DR24
30"	A-DR30

[View this product](#)

## Pull-out Refuse & Recycling



Thick marine grade aluminum construction. All outdoor grade 304 stainless steel hardware. Includes choice of powder coating.

Width	SKU
12"	A-GBG12
18"	A-GBG18
21"	A-GBG21
24"	A-GBG24

[View this product](#)

# Finished Panels

## Finished End Panel



Aesthetic finished end panel. Thick marine grade aluminum construction. Includes self-leveling toe kick and choice of powder coating. Only required when the side(s) of the kitchen are visible.

Depth	SKU
28 3/4"	A-ENDP28
32"	A-ENDP32
38 5/8"	A-ENDP38

[View this product](#)

## Finished Back Panel



Aesthetic finished back panel. Thick marine grade aluminum construction. Includes self-leveling toe kick and choice of powder coating. To allow proper air circulation, grill and power burner cabinets are equipped with the vented model. This product is only required when the back of the kitchen is visible.

Width	SKU
12"	A-BCKP12
18"	A-BCKP18
21"	A-BCKP21 and A-BCKP21-V
24"	A-BCKP24
27"	A-BCKP27
30"	A-BCKP30 and A-BCKP30-V
33"	A-BCKP33
36"	A-BCKP36 and A-BCKP36-V
42"	A-BCKP42 and A-BCKP42-V
48"	A-BCKP48 and A-BCKP48-V
62"	A-BCKP62 and A-BCKP62-V
Corner Back Panel	A-BCKP-CRNR

[View this product](#)

# Gardening

## Countertop Planters



Designed for small herb gardens or annuals, this planter sits directly on the countertop. Fully welded and made of thick marine grade aluminum. Includes choice of powder coating in any one of our standard colors.

Size	SKU
18 x 6 x 8"	A-PLANTER-COUNTER-18x6x8
24 x 6 x 8"	A-PLANTER-COUNTER-24x6x8
30 x 6 x 8"	A-PLANTER-COUNTER-30x6x8

[View this product](#)

## Cube Planters



Designed to fill a space without adding extra storage, a Cube Planter is a beautiful and functional addition to an outdoor kitchen. Freestanding, fully welded and made of thick marine grade aluminum. Includes choice of powder coating in any one of our standard colors.

Size	SKU
18 x 18 x 18"	A-PLANTER-CUBE-18x18x18
21 x 21 x 21"	A-PLANTER-CUBE-21x21x21
24 x 24 x 24"	A-PLANTER-CUBE-24x24x24
28 x 28 x 28"	A-PLANTER-CUBE-28x28x28
36 x 36 x 36"	A-PLANTER-CUBE-36x36x36

[View this product](#)

## Column Planters



Our Column Planters can be styled in a variety of ways. They can be used as a corner unit, at the end of a kitchen, or combined with one of our shorter Cube planters. Their dimensions are designed to match our cabinetry for an integrated look. Freestanding, fully welded and made of thick marine grade aluminum.

Size	SKU
24 x 24 x 36"	A-PLANTER-COLUMN-24x24x36
28 x 28 x 36"	A-PLANTER-COLUMN-28x28x36

[View this product](#)

## Partition Planters



Designed for placement behind a kitchen to create a freestanding “living” backsplash structure, Partition Planters are also ideal for delineating a space and creating more intimate environments. Option for direct ground placement is also available and creates a seamless backdrop to your Urban Bonfire kitchen.

Size	SKU
30 x 10 x 42”	A-PLANTER-PARTITION-30x10x42
36 x 10 x 42”	A-PLANTER-PARTITION-36x10x42
42 x 10 x 42”	A-PLANTER-PARTITION-42x10x42
42 x 12 x 42”	A-PLANTER-PARTITION-42x12x42

[View this product](#)

## Slatwall Backsplash



Our backsplash system must be installed against an existing wall or structure. Installation requirements may vary based on site conditions, local codes, equipment specifications and other factors. Check with your local licensed professional to ensure full and complete compliance to codes.

Description	Width	SKU
Small	6” – 48”	A-SLATWALL-SMALL-PANEL
Large	48 ¼” – 96”	A-SLATWALL-LARGE-PANEL

[View this product](#)

## Trough Planters



Designed for lower gardening plots Trough Planter adds form and function to an outdoor environment. Freestanding, fully welded and made of thick marine grade aluminum. Includes choice of powder coating.

Size	SKU
36 x 24 x 7”	A-PLANTER-TROUGH-36x24x7
48 x 18 x 10”	A-PLANTER-TROUGH-48x18x10
48 x 24 x 9”	A-PLANTER-TROUGH-48x24x9
48 x 24 x 20”	A-PLANTER-TROUGH-48x24x20

[View this product](#)

## Clip-In Planters



Clip-in planters accessory for modular slatwall backsplash. Dimensions Length 6” x Width 12” x Height 6”.

Dimensions	SKU
L6” x W12” x H6”	A-CLIPPLANTER

[View this product](#)

## IPE Wood Bench Insert



Our 48 x 24 x 20 Trough Planter can be combined with our IPE Bench Insert to create a convenient sitting space as well as a gardening plot. Freestanding, fully welded and made of thick marine grade aluminum. Includes choice of powder coating.

SKU
A-PLANTER-WOODBENCH-24x24 (shown with A-PLANTER-TROUGH-48x24x20)

[View this product](#)

## Utility Hook Kit



304 outdoor grade stainless steel utility hook kit for use with the slatwall backsplash. Set of 6.

SKU
A-SLATWALL-HOOK-KIT



# Others

## Corner Cabinet



Corner support module. Thick marine grade aluminum construction. Includes self-leveling toe kick and choice of powder coating.

Size	SKU
32 3/4"	A-CRNR

[View this product](#)

## Side Trims

Custom fillers for outdoor kitchens that are between walls. Thick marine grade aluminum construction and includes choice of powder coating.



“Filler style” side trim is a full height, single-piece filler. To be cut to height and fastened to cabinet side during installation.

Model	Width
Filler style	3/4" – 2"

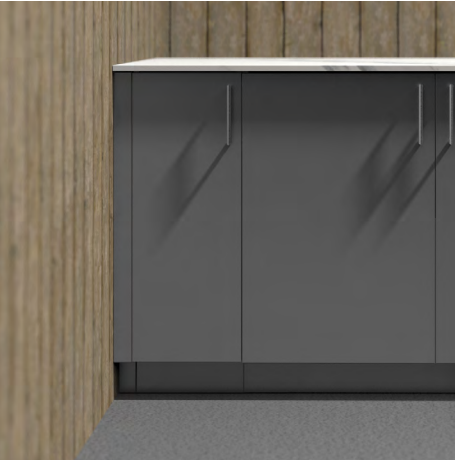

“Panel style” side trim is a custom filler for 2 1/4" width and over. Includes self-leveling toe kick and choice of powder coating.

Model	Width
Panel style	2 1/4" and over

## Full-length Toe Kick



Full-length toe kick for a seamless look. Thick marine grade aluminum construction and includes choice of powder coating. To be cut on site.

Length	Height	SKU
96"	7"	A-FULLTK-96x7

# Appliance Kits

## Undercounter Appliance Kit



Structural finishing kits for outdoor refrigerators, ice makers, keg tappers or freezers. Thick marine grade aluminum construction. Includes front countertop support spacer, finished back panel, self-leveling toe kick and choice of powder coating.

Width	SKU
15"	A-FRDG15
18"	A-FRDG18
20.75"	A-FRDG20.75
21.5"	A-FRDG21.5
22"	A-FRDG22

[View this product](#)

## Large Undercounter Appliance Kit



Structural finishing kits for outdoor refrigerators, ice makers, keg tappers or freezers. Thick marine grade aluminum construction. Includes a full panel countertop support, finished back panel, self-leveling toe kick and choice of powder coating.

Width	SKU
24"	A-FRDG24
24.875"	A-DW24.875
25"	A-FRDG25
28.5"	A-FRDG28.5
30"	A-FRDG30

[View this product](#)

## Reinforced Undercounter Appliance Kit



Structural finishing kits for outdoor refrigerators, ice makers, keg tappers or freezers. Thick marine grade aluminum construction. Includes a full panel countertop support, finished back panel, self-leveling toe kick and choice of powder coating.

Width	SKU
36"	A-FRDGRIN36
39"	A-FRDGRIN39
48"	A-FRDGRIN48

[View this product](#)

## Undercounter Appliance Overlay Panels



Give a seamless look to your outdoor kitchen with appliance overlay panels. Available for 15" and 24" undercounter appliances. Handle included separately, to be installed on site. Panel fabricated to the specifications provided by the appliance manufacturer.

Model	SKU
15" standard	A-FPANEL-15
15" dual drawers	A-FPANEL-15-2DRAWER
24" standard	A-FPANEL-24
24" dual drawers	A-FPANEL-24-2DRAWER

## Warming Drawer Insert



Structural insert for warming drawers. Made of thick marine grade aluminum construction, includes self-leveling toe kick and choice of powder coating.

**SKU**

A-FP-WARMINGDRAWER-INSERT

# Cabinet Specifications

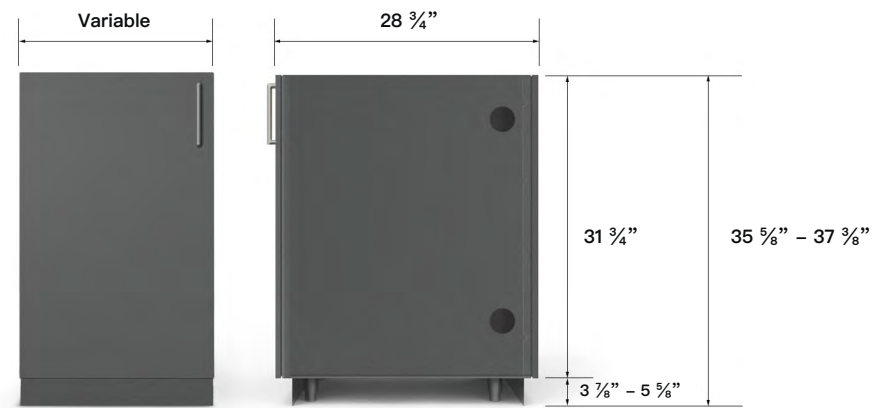

**Door Catch**  
Discreet, heavy duty magnetic catch system.

Full interior and exterior **NACRAE™** anti-microbial powder coated finish.

**Conduit Holes**  
Designed to easily connect services (wire, pipes, etc.) between cabinets.

**Insulated Door**  
Dual panel doors with solid insulated cores.



**Electrical and Plumbing**  
Removable panels to allow access to outside services.

**Self-leveling Toe Kick**  
Adapts to slope and outdoor site conditions. Simple removal and replacement designed for easy cleaning or seasonal maintenance.

**Hardware**  
Outdoor grade 304 stainless steel.



		CLASSICS COLLECTION	CUSTOM DESIGN	
<b>NACRAE™ POWDER COATED FINISHES</b>	ANTHRACITE	•	•	
	ARTESAN		•	
	CHANTILLY	•	•	
	CLAY	•	•	
	ONYX		•	
	PEWTER		•	
<b>HANDLES</b>	<b>POWDER COATED 316 STAINLESS STEEL</b>	316 STAINLESS STEEL		•
		ANTHRACITE	•	•
		ARTESAN		•
		CHANTILLY	•	•
		CLAY	•	•
		ONYX		•
	<b>SOLID BRONZE<sup>1</sup></b>	PEWTER		•
		BAUHAUS (3312)		•
		URBAN (337)		•
		PULL (341)		•
<sup>1</sup> Please contact us for available finishes.				
<b>COUNTERTOPS</b>	KEON	•		
	DANAЕ	•		



**NEW**

Our **NEW** Sample Kit is the perfect tool to help you plan and visualize your dream outdoor kitchen.

It includes:

Samples of our NACRAE™ powder coated finishes;

Samples of DEKTON® countertop finishes available for our Classics collection;

Our Request for Design form and an Urban Bonfire pencil to collect information about your spatial parameters and design “wish list”!

Apply for the program at  
[urbanbonfire.com](http://urbanbonfire.com)

## Professional Partner Program

The Urban Bonfire Professional Partner Program was developed to provide our Professional Partners with personalized service and support from our in-house design specialists along with exclusive rewards and joint content opportunities. Our program is open to approved designers, architects, builders, developers and landscape firms.

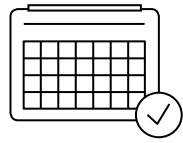

### Exclusive Professional Partner Events & Trade Shows

Join us alongside industry-leading design professionals and brands to experience our products first-hand at trade shows and exclusive Professional Partner events.

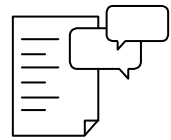

### Professional Design, Quoting and Technical Support

Work with our experienced and dedicated in-house design team and receive full back-end support and quality resources including drawings, technical specifications and expertise to ensure that your project is completed effectively and efficiently.

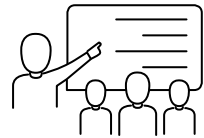

### Training Sessions

Schedule in-person or virtual trainings for you and your team. Gain access to our exclusive Fireside Chat Live sessions, short and high-impact live trainings on Zoom that are each followed by a Q&A with a member of our team.

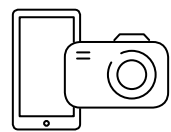

### Joint Content & Marketing Opportunities

We love to celebrate our professional partners and their clients. Work with our team to create an impactful piece of content highlighting your work and expertise and share the story behind your project.

Apply to our Professional Partner Program and join our community to participate in exclusive events like this.

## Urban Bonfire Atelier

Noun | A · tel · ee · ay

Atelier is a French word describing an artist's studio or workshop. It can also describe a group of artists, designers or architects working collectively. An atelier is a space of creativity, learning and connection.

Urban Bonfire Atelier brings together industry-leading design professionals and brands in a casual and intimate setting to discuss what outdoor space activation means to them. It allows us to share our expertise as a team, but also to learn from individuals who are out in the field and using our products and services first-hand.





URBAN  
*Bonfire*<sup>®</sup>  
URBAN



@urbanbonfire  
#YourKitchenOutdoors

CONTACT US

www.urbanbonfire.com  
design@urbanbonfire.com  
1 (866) 898.5354