



PERLICK RESIDENTIAL DESIGN GUIDE

QUALITY AND INNOVATION THAT

INSPIRE



24" Signature Series Dual-Zone Refrigerator/
Wine Reserve (left), 24" Signature Series Adara
Beer Dispenser, 2 Tap

- WHAT MAKES IT A PERLICK..... 4
- OUTDOOR REFRIGERATION..... 6
- MARINE MATERIALS UPGRADE..... 8
- ELEVATE YOUR HOME EXPERIENCE..... 10
- DUAL-ZONE REFRIGERATION..... 12
- DELICIOUS DETAILS..... 14
- SEAMLESS INTEGRATION..... 16
- DON'T FORGET THE BEER..... 17
- COMMITMENT TO SUSTAINABILITY..... 18
- INDUSTRY'S BEST WARRANTY..... 19



Enjoy ice cold beverages, brewery-fresh draft beer, the perfectly chilled vintage, crisp fruits and vegetables bursting with flavor, and even chilled face cream – all made possible with Perlick’s quality line of residential undercounter refrigeration.

As the leader in high quality commercial refrigeration and bar solutions for the world’s finest restaurants, bars, stadiums, and entertainment venues, Perlick offers homeowners the opportunity to bring that same level of quality into the comfort of their own home with our line of luxury residential products that blend professional level performance with exquisite style and modern functionality.

GET INSPIRED. CHOOSE PERLICK.



HANDCRAFTED SINCE 1917.....20

RAPIDCOOL REFRIGERATION 21

SIGNATURE SERIES..... 22

SIGNATURE SERIES MOBILE BARS AND MOBILE TAP 34

C-SERIES / ADA HEIGHT COMPLIANT 36

ICE MAKERS..... 38

COLUMN REFRIGERATORS / FREEZERS / WINE RESERVES 40

DOOR STYLES AND ACCESSORIES..... 44

MODEL SPECIFICATION GUIDE 48

Industry's largest collection of **ENERGY STAR™ Certified** undercounter refrigeration



Digital controller with audible door alarm provides precision temperature control and readout



Food and beverages are brightly illuminated by choice of **Crisp White** or **Cool Blue** adjustable LED lighting



Industry Exclusive **RapidCool™ Forced-Air Refrigeration System's** superior construction provides ideal combination of energy efficient operation and powerful refrigeration performance ideal for food and beverages

Sleek stainless steel interiors are not only beautiful to look at, but also provide a sanitary environment resistant to stains and odors



Stock and retrieve product with ease with adjustable **Full Extension Pullout Shelves** for all models - including refrigerators



Two inch thick foamed-in-place Insulation provides industry leading protection against outside ambient and vibration



All models are **available with stainless steel or fully integrated overlay panel-ready fronts**. All doors are **reversible**, and **stainless steel doors can be converted to overlay models** with ease.



Industry-best **6 Year Parts and Labor Warranty** on all undercounter refrigeration. 2 year Parts and Labor Warranty offered on all ice makers.





WHAT MAKES IT A PERLICK?

There is a reason that Perlick is regarded as the industry leader in undercounter refrigeration. Unmatched cooling performance is complemented by a bevy of thoughtful design details for convenience and beauty.

MEET THE INDUSTRY'S WIDEST SELECTION OF *OUTDOOR REFRIGERATION*

With **over 125 models** to choose from, Perlick boasts the largest portfolio of undercounter refrigeration UL-rated for outdoor use. Available in 15- and 24-inch configurations, Perlick refrigerators, beverage centers, wine reserves, beer dispensers, freezers, and ice makers are designed to take your outdoor entertaining space to the next level.

Perlick's patented **Signature Series Dual-Zone** models offer two independently-controlled temperature zones within a single 24" footprint to make the most of your available space. The **Signature Series Shallow Depth** collection of 18" depth refrigeration is perfect for balcony patios that require an appliance with a shallow depth.

See below to learn more about what makes Perlick outdoor models special.



A full line of accessories take your Perlick from day to night, including our industry-exclusive **Martini Rack** – perfect for entertaining



Store fresh herbs, citrus, snacks, and beverages in Perlick's industry-exclusive **15" Signature Series Outdoor Refrigerator Drawers**



Perlick's Anti-Condensation System™ heats the front face of the cabinet, eliminating condensation and extending product life in high humidity environments



Perlick's exclusive Signature Series Flow Control Faucet is constructed of stainless steel and features the industry-exclusive flow control lever to expertly pour your favorite craft beers



RAPIDcool™ forced air-cooled dispensing towers keep beer cold from the keg to the faucet by circulating cold through and around beer lines



The unmatched cooling power of Perlick's RAPIDcool™ forced-air refrigeration system keeps food at a safe and consistent temperature - even on hot summer days



Up to 70% faster cooling than leading competitor with the industry-exclusive RapidCool™ Refrigeration System

(Left to right) 24" Signature Series Outdoor Freezer, 15" Signature Series Outdoor Refrigerator Drawers, 24" Signature Series Outdoor Beer Dispenser, Signature Shallow Depth Outdoor Beverage Center and Signature Shallow Depth Outdoor Refrigerator

BATTLE THE HARSHTEST CONDITIONS WITH A *MARINE MATERIALS UPGRADE*

Coastal areas are the perfect place for luxury outdoor kitchens, but when presented with the extreme conditions of these environments, salt and sand can take their toll on your outdoor refrigeration equipment. You asked, we listened. Perlick is happy to announce the availability of an all-new Perlick Armor™ Marine Materials Upgrade for our Signature Series equipment, providing optimal corrosion resistance for food and beverage storage safety. Designed for life in even the most extreme coastal conditions, it allows you to enjoy the ultimate in refrigeration wherever you find paradise.



(Left to right) 24" Signature Series Dual-Zone Refrigerator/Freezer Drawers, 24" Signature Series Refrigerator, 24" Signature Series Dual-Zone Wine Reserve, 15" Signature Series Refrigerator Drawers



(Left to right) 24" Signature Series Dual-Zone Refrigerator/Freezer Drawers, 24" Signature Series Dual-Zone Wine Reserve/Wine Reserve, 15" Signature Series Refrigerator Drawers

PERLICK MARINE GRADE SIGNATURE SERIES UNDERCOUNTER MODELS

Components of Perlick Armor™

- Mix of all 316 and 304 stainless steel for optimal corrosion resistance food and beverage storage safety
- Upgraded 18-8 stainless steel and zinc plated fasteners ensure rust won't form in attachment zones
- E-coated condensers add durability to the refrigeration system in the most extreme conditions
- Available on all HP and HH Series residential models

Along with the standard Signature Series features:

- Robust 1000 BTU refrigeration system powered by Perlick's exclusive variable speed compressor provides industry-leading cooling capabilities and intuitive temperature control, which means the system will only run when it senses a temperature rise
- Superior construction provides ideal combination of energy efficient operation and powerful refrigeration performance ideal for food and beverage
- Front vented, RAPIDcool™ forced air refrigeration system provides the most energy efficient cool down, up to 70% faster than leading competitors
- Illuminated by dual-color LED lighting, giving you the option of 6000K Crisp White or Cool Blue lighting with just the press of a button
- At 32" tall, the Shallow Depth collection is ADA height compliant for accessible design needs

* Photos may vary from actual product.



ELEVATE YOUR
***HOME ENTERTAINING
EXPERIENCE***

Perlick's Tobin Ellis Signature Series Residential Mobile Bars bring the best designs featured at the world's top bars and restaurants to the comfort of your own home! Perlick's line of mobile bars will elevate your home entertaining experience while making you feel like a professional mixologist utilizing our "bartender cockpit" design and luxury finishes.



PERLICK MOBILE BAR MODELS

- Homeowners have the ultimate in design flexibility with the option of either the Tobin Ellis designed **Limited Edition** or the **Signature Series Mobile Bars** for the look that matches their home's design aesthetic
- The Perlick Mobile Tap is versatile and flexible for dispensing beverages in venue spaces with two taps and a 24" refrigeration unit that can dispense Nitro coffee or wine, beer and wine, two varieties of wine, or two varieties of beer
- Easily move the bar anywhere inside or outside of your home for expanding your upscale home entertaining needs
- Available in 46", 70" with 2 drainboards, 70" with hand sink configurations, and 70" limited edition with custom finishes
- Features ample lower storage area for glasses, dry goods, canned goods, or beverages
- Bartender cockpit features bottle rail, insulated ice chest, and insulated bottle well



HC24RS4S-J0-SLFLT
Mobile Tap Beer
Dispensers



RMB-001
70" Limited Edition Mobile
Bar with 2 drainboards
and custom finishes

TWO TEMPERATURES. ONE 24" FOOTPRINT.

DUAL-ZONE REFRIGERATION

Perlick's full line of dual-zone refrigeration boasts two independently controlled temperature zones, serving double duty for the storage and service of your favorite foods and beverages within the same 24" footprint.

Powered by Perlick's exclusive RAPIDcool forced-air refrigeration system for exceptional cooling performance and sleek, stainless steel interiors for beauty and durability, Signature Series Dual-Zone units are built with form and function in mind. Indoor and UL-approved outdoor freezer/refrigerator drawer, refrigerator/wine reserve, and wine reserve/wine reserve models are available.

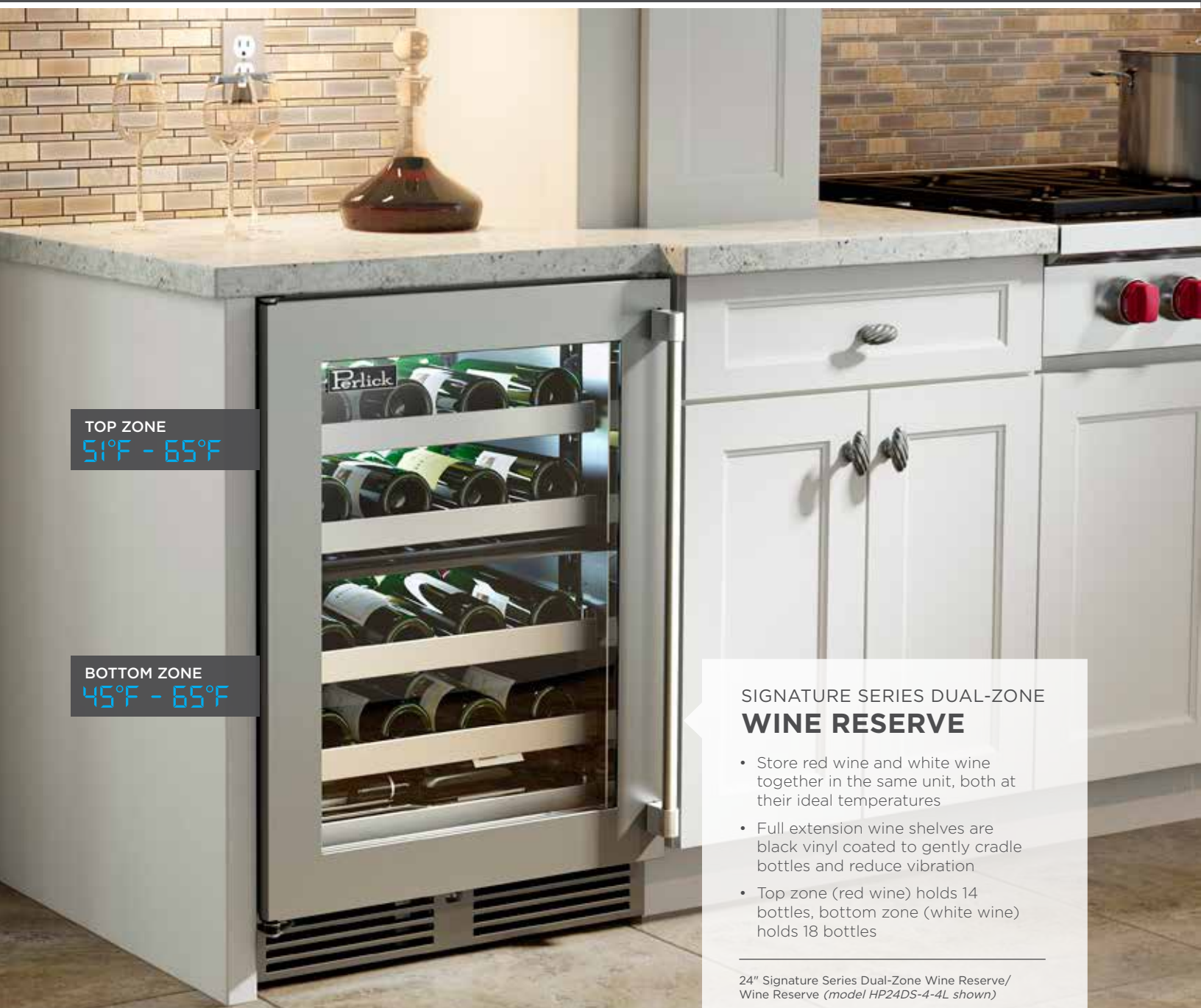

TOP ZONE
51°F - 65°F

BOTTOM ZONE
45°F - 65°F

SIGNATURE SERIES DUAL-ZONE WINE RESERVE

- Store red wine and white wine together in the same unit, both at their ideal temperatures
- Full extension wine shelves are black vinyl coated to gently cradle bottles and reduce vibration
- Top zone (red wine) holds 14 bottles, bottom zone (white wine) holds 18 bottles

24" Signature Series Dual-Zone Wine Reserve/
Wine Reserve (model HP24DS-4-4L shown)

SIGNATURE SERIES DUAL-ZONE FREEZER/REFRIGERATOR DRAWERS

- Store fresh and frozen food at their appropriate temperatures in the same small footprint
- Top drawer is deep enough to accommodate a gallon of milk or other similarly sized tall items
- Separate zones ensure freezer temperatures won't be transferred to the top drawer, putting foods and drinks at risk of freezing

24" Signature Series Dual-Zone Outdoor Freezer/Refrigerator Drawers (model HP24ZO-4-5DL shown)



TOP ZONE
30°F - 42°F

BOTTOM ZONE
-10°F - 10°F



TOP ZONE
45°F - 65°F

BOTTOM ZONE
33°F - 42°F

SIGNATURE SERIES DUAL-ZONE REFRIGERATOR/ WINE RESERVE

- Store wine and food (or cold beverages) at their appropriate temperatures
- Accommodates 14 bottles of wine in top zone
- Bottom zone features full extension refrigerator shelf for easy stocking and retrieving of product

24" Signature Series Dual-Zone Refrigerator/Wine Reserve (model HP24CS-4-4L with custom overlay shown)

BEHOLD THE DELICIOUS DETAILS OF OUR *COLUMN REFRIGERATORS, FREEZERS, AND WINE RESERVES*

Our 24" and 30" refrigerators feature Perlick's **patented QuatroCool™ cooling system**, offering four independently controlled temperature zones for deli, meat/fish, produce, and beverages. Our **tip out produce bin** features proven food preservation technology that keeps greens fresher and crisper, longer. **Advanced electronic monitoring of humidity levels** adds moisture back into the compartment, while our filtration system removes the gases emitted by fruits and vegetables.

Our freezers offer a commercial-grade, stainless-steel interior, **full-extension open drawer bins**, and **vibrant LED lighting**. It incorporates our quiet, powerful, **frost-free cooling** that has made us the choice of fine commercial venues for more than 100 years. Pair your freezer with the 24" or 30" column refrigerator for the ultimate fresh and frozen food preservation system.

Our 24" Column Single- and Dual-Zone Wine Reserves feature **vibration-resistant soft-coat glide out shelves** and advanced humidity, air filtration, and temperature control. Vibrant blue or white LED roll-on theatre lighting adjusts for display or storage, and emits no UV light to protect against oxidation and degradation. **bronze tinted, UV resistant glass** is Low-E and argon filled, protecting from light exposure which can cause oxidation in wine and degrade it over time. **Advanced technology maintains humidity levels** to preserve corks and prevent oxidation.

QuatroCOOL™ TECHNOLOGY



Perlick QuatroCool™ cooling system keeps food fresh for longer in 4 zones

- Main compartment
- Deli drawer
- Meat and fish drawer
- Tip out produce bin

24" Column Freezer (left) and
24" Column Refrigerator (right)



Instead of plastic, our column refrigeration offers brushed stainless steel and glass interiors, resulting in a non-porous, easy to clean, and elegant looking appliance



PerliQ™ touch-screen control panel disappears into the backdrop until it's awoken with a touch. Customize temperature preferences in precise, one degree increments and activate Sabbath mode with the touch of a button.



Tip out produce bin uses advanced electronic monitoring of humidity levels to add real moisture back into the compartment, while our filtration system removes gases emitted by some fruits and vegetables

ADD TO YOUR HOME'S CHARM WITH *INTEGRATION*

Homeowners often don't want appliances taking away from their home's visual appeal. Integrating your appliances offers everything from sleek design to space saving solutions. Set your appliances flush with surrounding cabinetry, highlighting Perlick's renowned brushed stainless steel finish, or choose our panel-ready overlay options to complement the aesthetic of your kitchen, family room, back yard, bathroom, or rec room.



AND DON'T FORGET ABOUT *THE BEER*

We've spent decades developing proprietary technologies in both refrigeration and beverage dispensing to serve that perfect cold beer to crowds of thousands. You can now enjoy the same experience and quality in the comfort of your own home surrounded by friends and family.



Perlick designed and engineered 630SS and 650SS (*shown*) beer faucets are stainless steel and standard on all models - **it's what the professionals use**



Adjust the speed of the pour for multiple craft beers or when foaming occurs. It's another award-winning **Perlick exclusive** you won't find anywhere else.



Towers are air-cooled with **RAPIDcool™ forced-air technology** to keep beer cold from keg to faucet



Perlick's exclusive accessories, **S-Series low profile keg couplers**, are available for all beer dispenser models (for Newcastle, Stella Artois, Strongbow, Pilsner Urquell, Heineken, etc.)



OUR COMMITMENT TO *SUSTAINABILITY*

Perlick features the industry's largest selection of Energy Star™ Rated undercounter refrigeration and utilizes clean technologies like Hydrocarbon Refrigerant for their very low Global Warming Potential (GWP). We've also been a partner on the Partners for a Cleaner Environment Honor Roll for the Milwaukee Metropolitan Sewerage District (MMSD) since 2002.





INDUSTRY-BEST 6-YEAR WARRANTY

At Perlick we don't just "walk the walk." We have so much confidence in our products we upped our 3-Year Warranty to a FULL 6 Years - another industry exclusive.



24" C-Series Beverage Center



SINCE 1917

CRAFTSMANSHIP IS IN OUR DNA

We're a family-owned company, spanning 100+ years and five generations of Perlick family members who are dedicated to providing the industry's highest quality commercial and residential refrigeration. Every Perlick refrigerator is built to exacting standards to meet strict commercial regulations, which means you can be confident that your Perlick is built to last under even the heaviest usage.

We've mastered the art of balancing innovation and craftsmanship. You can trust Perlick to provide precision temperature control and build every unit with the finest features and materials.



SUPERIOR
TARE 15

THE MOST INNOVATIVE REFRIGERATION SYSTEM IN THE INDUSTRY

RAPIDcool™

Perlick has refrigeration down to a science. With a century's worth of experience in designing, engineering, and manufacturing bar and beverage refrigeration for the commercial market, we've mastered the art of building cutting-edge refrigeration systems that balance power and precision. All Perlick models boast RAPIDcool™ forced-air refrigeration, providing the industry's most energy efficient cooling with up to 70% faster cooling speeds than leading competitors. Read on to compare competitor refrigeration systems.

PERLICK RAPIDCOOL™ FORCED-AIR REFRIGERATION

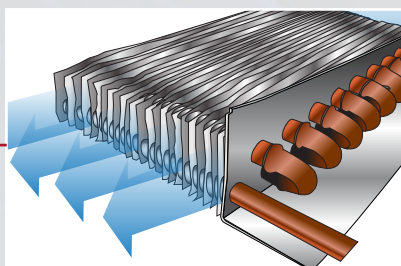
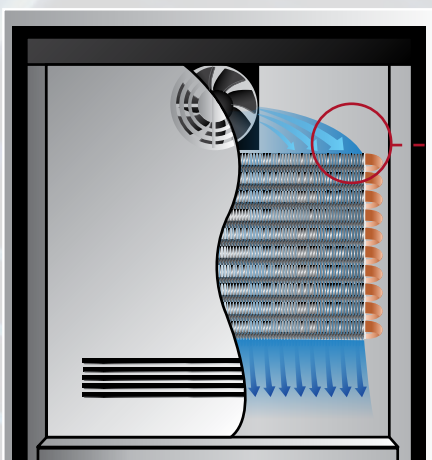

7x

Air is blown with a powerful fan through thousands of aluminum fins, providing superior cooling with 7x the cooling surface compared to cold plate models.

COMPETITOR COLD PLATE REFRIGERATION

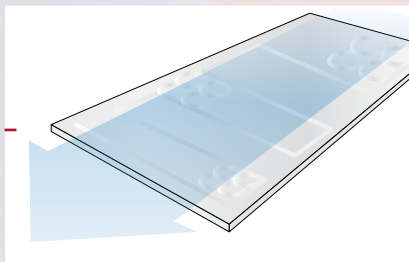
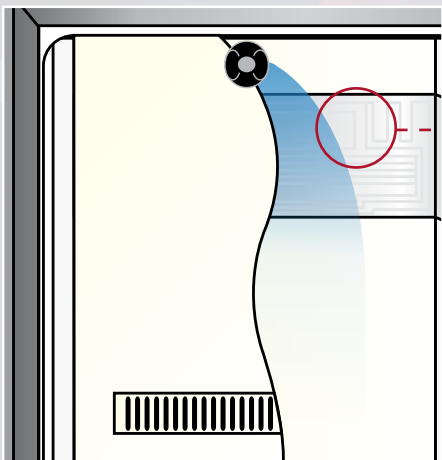

Air is blown over a thin aluminum sheet known as a cold plate.

MEET THE *SIGNATURE SERIES*

Our flagship collection of undercounter refrigeration, the Perlick Signature Series, comes in a variety of sizes and styles to fit any space and storage need. It's the crème de la crème of undercounter refrigeration, and every Signature Series model is available for indoor or outdoor use.





PERLICK SIGNATURE SERIES UNDERCOUNTER REFRIGERATION MODELS

- Available in 15" and 24" models, as well as the exclusive Signature Series Shallow Depth models which feature an 18" depth
- Robust 1000 BTU refrigeration system powered by Perlick's exclusive variable speed compressor provides industry-leading cooling capabilities and intuitive temperature control which means the system will only run when it senses a temperature rise
- Front vented, RAPIDcool™ forced air refrigeration system provides the most energy efficient cool down, up to 70% faster than leading competitors
- State of the art digital temperature control with audible door alarm in all models
- Illuminated by dual-color LED lighting, giving you the option of 6000K Crisp White or Cool Blue lighting with just the press of a button
- Stainless steel interiors and exteriors for long life durability and easy cleaning
- All Signature Series products are available as indoor or UL-rated outdoor models
- Industry-exclusive Shallow Depth undercounter refrigeration that measures just 18" deep
- Measuring 32" tall, the Shallow Depth collection is ADA height compliant for accessible design needs



(Top: Left to right) 15" Signature Series Refrigerator, 24" Signature Series Drawers
(Bottom right) 18" Signature Series Shallow Depth Undercounter Wine Reserves with wood overlay



A REFRIGERATION SOLUTION FOR SPACES WHERE A TRADITIONAL 24" DEEP UNIT WON'T WORK.

Designers asked and we listened. We designed a cabinet with a slim profile and added our premium Signature Series features to create the **industry's first shallow depth refrigerator**. This industry exclusive collection of undercounter refrigeration measures just **18" deep** and 32" tall, ensuring our Shallow Depth units are also **ADA height compliant** for increased design flexibility.

(Left to right) 24" Signature Series Shallow Depth Wine Reserve, 24" Signature Series Shallow Depth Beverage Center, 24" Signature Series Shallow Depth Refrigerator

SIGNATURE SERIES REFRIGERATORS

Perlick proudly offers the industry's widest selection of undercounter refrigerators, making it easier than ever to add point-of-use refrigeration to anywhere inside - or outside - the home. Stainless steel interiors and energy efficient operation makes Perlick the perfect choice for all of your favorite foods and beverages.

FOOD SAFETY



Perlick's exclusive **RAPIDcool™ forced-air refrigeration technology** provides the industry's most energy efficient cool down using less energy while cooling up to 70% faster than leading competitors.

THE BEAUTY OF STAINLESS



Perlick's sleek **stainless steel interiors** are easy to clean and resistant to odors, stains, and mold - it's what the professionals demand in their kitchens.

UNMATCHED SHELVING



Perlick's exclusive **full extension shelves** pull completely out of the cabinet to make stocking and retrieving product easy. Stainless steel ball bearing glides provide smooth movement in and out of the cabinet even when fully stocked.

AVAILABLE MODELS

For complete model number listing, product specs, and quick reference, see page 50.

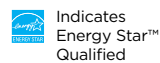

15" SIGNATURE SERIES REFRIGERATORS

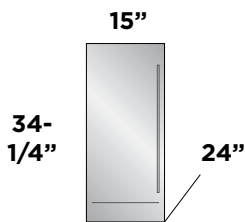

- 1 Stainless Steel Solid Door
- 2 Fully Integrated Solid Doors*



- 4 Stainless Steel Glass Doors
- 4 Fully Integrated Glass Doors*



- 5 Stainless Steel Drawers
- 6 Fully Integrated Drawers*

24" SIGNATURE SERIES REFRIGERATORS (Single Zone Models)

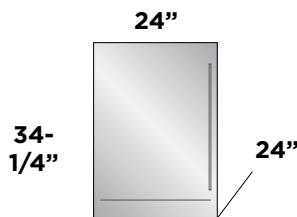

- 1 Stainless Steel Solid Door
- 2 Fully Integrated Solid Doors*



- 4 Stainless Steel Glass Doors
- 4 Fully Integrated Glass Doors*



- 5 Stainless Steel Drawers
- 6 Fully Integrated Drawers*

24" SIGNATURE SERIES REFRIGERATORS (Dual Zone Models)

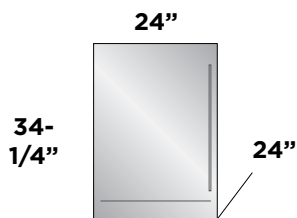

- 5 Stainless Steel Drawers
- 6 Fully Integrated Drawers*



- 1 Stainless Steel Solid Door
- 2 Fully Integrated Solid Doors*



- 4 Stainless Steel Glass Doors
- 4 Fully Integrated Glass Doors*

SIGNATURE SERIES SHALLOW DEPTH REFRIGERATORS (ADA height compliant)

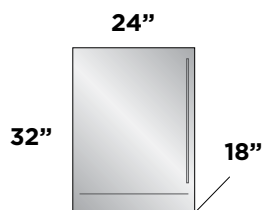

- 1 Stainless Steel Solid Door
- 2 Fully Integrated Solid Doors*



- 4 Stainless Steel Glass Doors
- 4 Fully Integrated Glass Doors*



24" Signature Series Dual-Zone Freezer/Refrigerator Drawers

NOW YOU CAN STORE ICE CREAM AND FRESH BERRIES IN THE SAME 24" FOOTPRINT

Perlick's exclusive **Dual-Zone Freezer/Refrigerator Drawers** feature two independently controlled temperature zones. The top drawer offers refrigeration temperatures and is deep enough for large items such as a gallon of milk. The freezer drawer below is perfect for storing a variety of frozen goods, including that secret stash of ice cream.

SIGNATURE SERIES FREEZERS

When it comes to stylish freezer solutions, Perlick offers it all with freezers that are energy efficient, powerful, and provide industry-leading drawer capacity. All Perlick freezers - including the Signature Series Dual-Zone Freezer/Refrigerator Drawers - feature forced-air refrigeration and maintenance-free defrosting.

MAINTENANCE-FREE



Maintenance-free defrosting makes owning and maintaining Perlick freezers simple.

THE BEAUTY OF STAINLESS



Perlick's **sleek stainless steel interiors** are easy to clean and resistant to odors, stains, and mold. It's what the professionals demand in their kitchens and it's available to you, too.

PRECISION AND CONTROL



Perlick's **state of the art digital controller** provides precise temperature readout and adjusts automatically for temperature consistency, and an audible door alarm warns user if door is held open.

AVAILABLE MODELS

For complete model number listing, product specs, and quick reference, see page 50.



24" SIGNATURE SERIES FREEZERS (Single Zone Models)

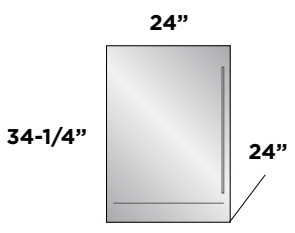

- 1 Stainless Steel Solid Door
- 2 Fully Integrated Solid Doors*



- 5 Stainless Steel Drawers
- 6 Fully Integrated Drawers*

24" SIGNATURE SERIES FREEZERS (Dual-Zone Models)

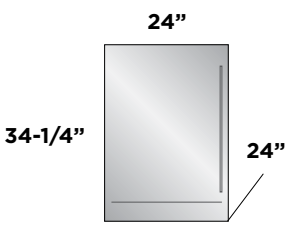

- 5 Stainless Steel Drawers
- 6 Fully Integrated Drawers*



STACKING KITS

RS-SK-15L/R / RS-SK-24L/R / RS-SK-18-L/R

Mix and match Perlick undercounter refrigeration to create custom modular refrigeration for anywhere inside or outside the home. Choose from refrigerators, freezers, beverage centers and wine reserves, as well as our dual-zone refrigeration, to create flexible storage for your specific refrigeration needs.

Photos may vary from actual product.

* This model comes ready to accept a custom panel



(Left to right) 24" Signature Series Dual-Zone Refrigerator/Wine Reserve, 24" Signature Series Adara Beer Dispenser

MAKE ENTERTAINING EASIER BY BRINGING YOUR BEVERAGES WITHIN ARM'S REACH

Beer, wine, soda, juices - all where you need them most. Our beverage centers eliminate trips from your theater room in the basement, your bedroom across the house, or your outdoor patio - wherever you entertain or just need a cold beverage nearby. And our Shallow Depth Beverage Centers are ADA height compliant for aging-in-place needs.

SIGNATURE SERIES BEVERAGE CENTERS

The elegance of a wine reserve meets the practicality of a refrigerator with Perlick's full line of beverage centers. With storage for up to 16 bottles of your favorite wine and a variety of canned and bottled beverages below, the Perlick beverage center keeps refreshments cold anywhere inside - or outside - the home.

FOR SHOW AND STRENGTH



Glass doors feature **Low E, Argon filled dual-pane thermal glass with UV resistant coating** to limit energy transfer through glass and add increased strength indoors or out.

RAPIDCOOL TECHNOLOGY



All models feature **Perlick's exclusive RAPIDcool™ forced-air refrigeration system** for the industry's most energy efficient cool down using less energy while cooling up to 70% faster than leading competitors.

UNMATCHED SHELVING



Perlick's exclusive **full extension shelves** pull completely out of the cabinet to make stocking and retrieving beverages easy. Our stainless steel ball bearing glides provide smooth movement in and out of cabinet even when fully stocked.

AVAILABLE MODELS

For complete model number listing, product specs, and quick reference, see page 50.

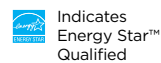

15" SIGNATURE SERIES BEVERAGE CENTERS

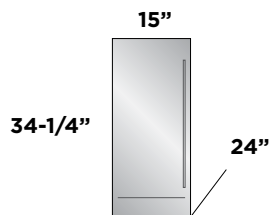

- 1 Stainless Steel Solid Door
- 2 Fully Integrated Solid Doors*



- 4 Stainless Steel Glass Doors
- 4 Fully Integrated Glass Doors*

24" SIGNATURE SERIES BEVERAGE CENTERS

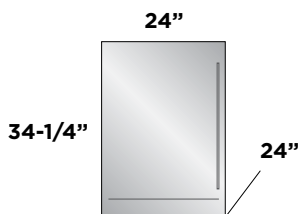

- 1 Stainless Steel Solid Door
- 2 Fully Integrated Solid Doors*



- 4 Stainless Steel Glass Doors
- 4 Fully Integrated Glass Doors*

SIGNATURE SERIES SHALLOW DEPTH BEVERAGE CENTERS (ADA height compliant)

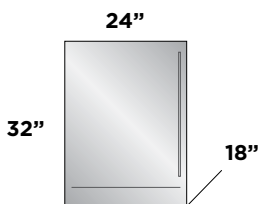

- 1 Stainless Steel Solid Door
- 2 Fully Integrated Solid Doors*



- 4 Stainless Steel Glass Doors
- 4 Fully Integrated Glass Doors*

SHELVING AND COMPARTMENT ACCESSORIES



RS-15-15R
Shelf, HP15 Refrigerator

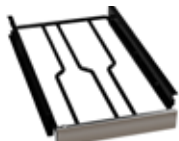

RS-15-15W
Shelf, HP15 Wine



RS-24-24R
Shelf, 24" Refrigerator

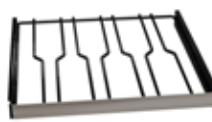

RS-24-24W
Shelf, 24" Wine



RS-24-24M
Shelf, 24" Martini Rack



RS-18-18R
Shelf, HH24 Refrigerator



RS-18-18W
Shelf, HH24 Wine



RS-24-24WD
Shelf, 24" Dual-Zone Wine



67115-15/67115-24
15" and 24" Wood
Wine Faces



67964
Stainless Steel Drawer
Dividers



(Left to right) 24" Column Wine Reserve, 24" Signature Series Beverage Center, 24" Signature Series Refrigerator with Martini Rack, 24" Column Wine Reserve

NO TWO WINE COLLECTIONS ARE THE SAME

Wine is complex. Whether a crisp white or a robust red, all wine is perishable and requires proper conditions to protect it from spoilage. To enjoy wine at its peak, Perlick wine reserves are designed to combat the common enemies of wine: temperature, vibration, oxygen, light, and odor.

SIGNATURE SERIES WINE RESERVES

Whether you are a wine novice or a collector of the finest vintages, Perlick has the answer for the storage and service of your prized bottles of wine. Store up to 45 bottles of your favorite wine in the Perlick patented 24" Signature Series Wine Reserve, or keep a small collection of 20 bottles on hand for gatherings in our 15" Signature Series Wine Reserve.

FOR SHOW AND STRENGTH



Glass doors feature **Low E, Argon filled dual-pane thermal glass with UV resistant coating** to limit energy transfer through glass and add increased strength indoors or out.

RAPIDCOOL TECHNOLOGY



All models feature **Perlick's exclusive RAPIDcool™ forced-air refrigeration system** for the industry's most energy efficient cool down using less energy while cooling up to 70% faster than leading competitors.

UNMATCHED SHELVING



Perlick's exclusive **full extension flex shelves** pull completely out of the cabinet to make stocking and retrieving wine bottles easy. **Stainless steel ball bearing glides** provide smooth movement in and out of cabinet even when fully stocked.

AVAILABLE MODELS

For complete model number listing, product specs, and quick reference, see page 50.



15" SIGNATURE SERIES WINE RESERVES

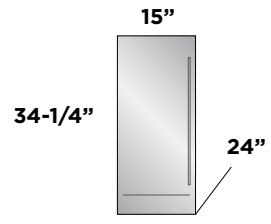

- 1 Stainless Steel Solid Door
- 2 Fully Integrated Solid Doors*



- 4 Stainless Steel Glass Doors
- 4 Fully Integrated Glass Doors*

24" SIGNATURE SERIES WINE RESERVES (Single Zone Models)

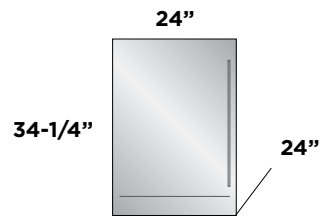

- 1 Stainless Steel Solid Door
- 2 Fully Integrated Solid Doors*



- 4 Stainless Steel Glass Doors
- 4 Fully Integrated Glass Doors*

24" SIGNATURE SERIES WINE RESERVES (Dual Zone Models)

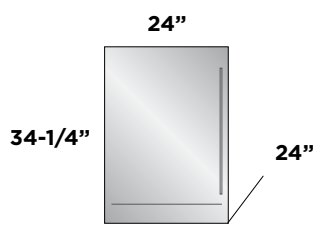

- 1 Stainless Steel Solid Door
- 2 Fully Integrated Solid Doors*



- 4 Stainless Steel Glass Doors
- 4 Fully Integrated Glass Doors*



- 4 Stainless Steel Glass Doors
- 4 Fully Integrated Glass Doors*

SIGNATURE SERIES SHALLOW DEPTH WINE RESERVES (ADA height compliant)

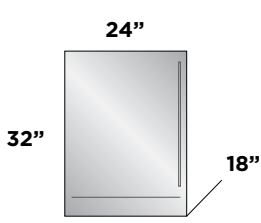

- 1 Stainless Steel Solid Door
- 2 Fully Integrated Solid Doors*



- 4 Stainless Steel Glass Doors
- 4 Fully Integrated Glass Doors*

Photos may vary from actual product.

* This model comes ready to accept a custom panel



24" Signature Series Beer Dispenser (Two Faucet Model)

POUR YOUR BEER LIKE THE PROS DO WITH PERLICK'S FULL LINE OF RESIDENTIAL INDOOR AND OUTDOOR BEER DISPENSERS

For decades, Perlick has designed and manufactured refrigeration and beer dispensing systems for bars, restaurants, and stadiums around the world. Our proprietary technologies in both refrigeration and beverage dispensing allow bartenders to serve perfectly chilled beer to crowds of thousands. Now you can pour like a pro in the comfort of your own home.

SIGNATURE SERIES BEER DISPENSERS

Perlick is the brand professionals trust to dispense beer at their bars, restaurants and stadiums around the world. We've taken the same, innovative technology we've been developing since prohibition to bring you the industry's best residential beer dispensers.

POWER AND CONTROL



Perlick patented dispensing technology, including the **Perlick 650SS Stainless Steel Flow Control Faucet**, works in tandem with Perlick's powerful refrigeration system to serve the perfect beer, pour after pour.

RAPIDCOOL TECHNOLOGY



All models feature **Perlick's exclusive RAPIDcool™ forced-air refrigeration system** for unmatched cooling capabilities and temperature control in the cabinet and up through the tower.

UNMATCHED CONSTRUCTION



Two-inch thick foamed in place Insulation provides industry-leading protection against outside ambient. **Stainless steel interiors** are heavy duty enough to stand up to kegs and are sanitary for easy cleaning.

AVAILABLE MODELS

For complete model number listing, product specs, and quick reference, see page 50.

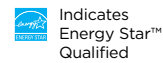

Indicates Energy Star™ Qualified



Outdoor Models Available

15" SIGNATURE SERIES BEER DISPENSERS

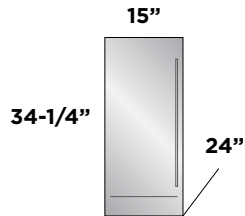

- 1 Stainless Steel Solid Door
- 2 Fully Integrated Solid Doors*



- 1 Stainless Steel Solid Door
- 2 Fully Integrated Solid Doors*

CAPACITY:
1/6
One 1/6 barrel

24" SIGNATURE SERIES BEER DISPENSERS (Single Faucet Models)

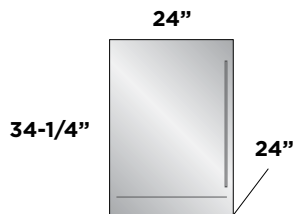

- 1 Stainless Steel Solid Door
- 2 Fully Integrated Solid Doors*



- 1 Stainless Steel Solid Door
- 2 Fully Integrated Solid Doors*

CAPACITY:
1/6 1/6
Two 1/6 barrels
OR
1/4
One 1/4 barrel
OR
SLIM 1/4
One slim 1/4 barrel

24" SIGNATURE SERIES BEER DISPENSERS (Two Faucet Models)

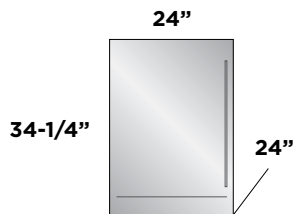

- 1 Stainless Steel Solid Door
- 2 Fully Integrated Solid Doors*



- 1 Stainless Steel Solid Door
- 2 Fully Integrated Solid Doors*

CAPACITY:
1/6 1/6
Two 1/6 barrels
OR
1/4
One 1/4 barrel
OR
SLIM 1/4
One slim 1/4 barrel

BEER DISPENSER ACCESSORIES



63797
Beer Dispenser
Cleaning Kit
(Includes pump, sanitizer,
and tools to clean lines)



BLC32 / BLC4
Sanitizer for Beer
Dispensers
(32 oz / 4 oz)



308-40C
Beer Faucet Lock
(Compatible with
630SS Faucets)



67141-1
Perlick Beer
Faucet Handle



630SS
630SS
Forward-Sealing Faucet



67782
Drip Pan for
Beer Dispensers



TAKE THE PARTY ANYWHERE
WITH THE PERLICK SIGNATURE
SERIES MOBILE BARS,
DESIGNED BY TOBIN ELLIS

Perlick's Tobin Ellis Signature Series Residential Mobile Bars bring the best designs featured at the world's top bars and restaurants to the comfort of your own home! Perlick's line of mobile bars will elevate your home entertaining experience while making you feel like a professional mixologist utilizing our "bartender cockpit" design and luxury finishes.

Tobin Ellis Signature Series
Limited Edition Mobile Bar

MEET THE *PERLICK MOBILE SERIES*

Perlick offers a full line of mobile products made for when a centralized bar isn't an option. We have the products you need to operate efficiently despite the labor shortage, all designed and built with the quality you can only expect from Perlick.

PERLICK MOBILE BARS AND MOBILE TAP

- Homeowners have the ultimate in design flexibility with the option of either the **Signature Series Limited Edition**, **Signature Series Mobile Bars**, or the **Perlick Mobile Tap** for the look that complements their home's aesthetic
- Easily move the bars anywhere inside or outside of your home for expanding your upscale home entertaining needs
- Available in 46", 70" with 2 drainboards, 70" with hand sink configurations, and 70" limited edition with custom finishes
- Features ample lower storage area for glasses, dry goods, canned goods, or beverages
- Bartender cockpit features bottle rail, insulated ice chest, and insulated bottle well
- Perlick Mobile Tap units include a two-faucet draft arm and a 24" refrigeration unit that can dispense beer, wine, coffee, and nitro infused beverages



AVAILABLE MODELS

For complete model number listing, product specs, and quick reference, see page 55.

PERLICK MOBILE TAP



HC24RS4S-J0-SLFLT
Mobile Tap Beer Dispensers



HC24RS4S-G0-SLFLT
Mobile Tap Nitro and Coffee or Wine - inside view



TOBIN ELLIS SIGNATURE SERIES LIMITED EDITION MOBILE BAR



RMB-001
70" Limited Edition Mobile Bar with 2 drainboards and custom finishes



RMB-001 Top View

TOBIN ELLIS SIGNATURE SERIES MOBILE BARS



RMB-002
70" Mobile Bar with drainboard and sink configuration



RMB-003
70" Mobile Bar with 2 drainboards



RMB-004
46" Mobile Bar

C-SERIES / ADA HEIGHT COMPLIANT SERIES

Inspired by our commercial offering, the C-Series includes a thoughtful selection of features in a 24" width. Select outdoor models available.

The industry's widest selection of ADA height compliant undercounter refrigeration features superior refrigeration and stainless steel interiors. It's a designer favorite for both residential and light commercial projects that require ADA compatibility.





24" ADA Height Compliant Series Beverage Center

C-SERIES AND ADA HEIGHT COMPLIANT MODELS

- Robust 800 BTU refrigeration system featuring Perlick's exclusive front vented, RAPIDcool™ forced air refrigeration system
- Rated for beverage and open food storage
- Digital temperature control with audible door alarm in all models
- Stainless steel interiors
- Full extension smooth glide shelving eliminates reaching into the back of the cabinet
- Industry-best 6 Year Full Parts and Labor Warranty
- ADA Series units feature 32" height and ADA height compliant product design for accessible and aging-in-place designs

ADA Compliant
32" Height



* Photos may vary from actual product.

C-SERIES PRODUCTS

AVAILABLE MODELS

For complete model number listing, product specs, and quick reference, see page 52.

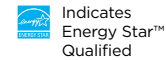

24" C-SERIES REFRIGERATORS

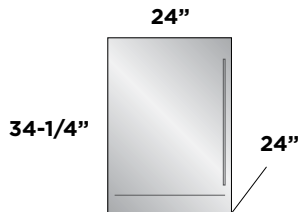

- 1 Stainless Steel Solid Door
- 2 Fully Integrated Solid Doors*



- 4 Stainless Steel Glass Doors
- 4 Fully Integrated Glass Doors*



- 5 Stainless Steel Drawers
- 6 Fully Integrated Drawers*

24" C-SERIES BEVERAGE CENTERS

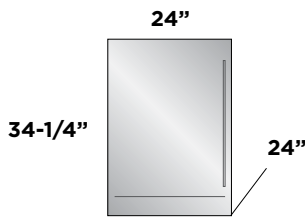

- 1 Stainless Steel Solid Door
- 2 Fully Integrated Solid Doors*



- 4 Stainless Steel Glass Doors
- 4 Fully Integrated Glass Doors*

24" C-SERIES WINE RESERVES

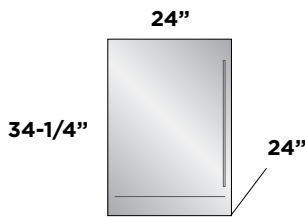

- 1 Stainless Steel Solid Door
- 2 Fully Integrated Solid Doors*



- 4 Stainless Steel Glass Doors
- 4 Fully Integrated Glass Doors*

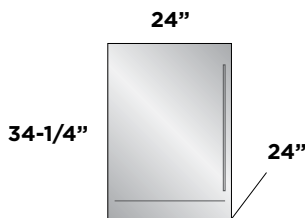

24" C-SERIES BEER DISPENSERS (Single and Two Faucet Models)



- 1 Stainless Steel Solid Door
- 2 Fully Integrated Solid Doors*



- 1 Stainless Steel Solid Door
- 2 Fully Integrated Solid Doors*

CAPACITY:
 Two 1/6 barrels
 OR
 One 1/4 barrel
 OR
 One slim 1/4 barrel

ADA HEIGHT COMPLIANT SERIES PRODUCTS

AVAILABLE MODELS

For complete model number listing, product specs, and quick reference, see page 52.

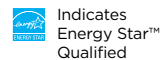

24" ADA HEIGHT COMPLIANT SERIES REFRIGERATORS

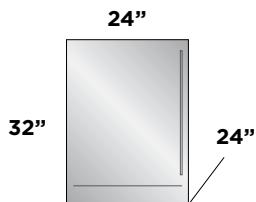

- 1 Stainless Steel Solid Door
- 2 Fully Integrated Solid Door *



- 4 Stainless Steel Glass Door
- 4 Fully Integrated Glass Door *



- 5 Stainless Steel Drawers
- 6 Fully Integrated Drawers *

24" ADA HEIGHT COMPLIANT SERIES FREEZERS

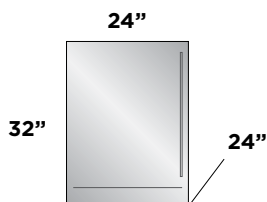

- 1 Stainless Steel Solid Door
- 2 Fully Integrated Solid Door *



- 5 Stainless Steel Drawers
- 6 Fully Integrated Drawers *

24" ADA HEIGHT COMPLIANT SERIES BEVERAGE CENTERS

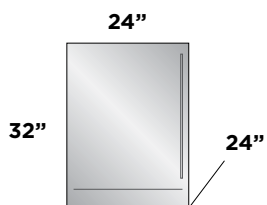

- 1 Stainless Steel Solid Door
- 2 Fully Integrated Solid Doors*



- 4 Stainless Steel Glass Doors
- 4 Fully Integrated Glass Doors*

24" ADA HEIGHT COMPLIANT SERIES WINE RESERVES

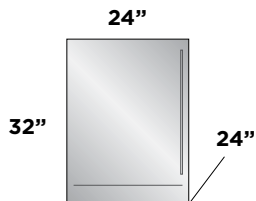

- 1 Stainless Steel Solid Door
- 2 Fully Integrated Solid Doors*



- 4 Stainless Steel Glass Doors
- 4 Fully Integrated Glass Doors*

ON THE ROCKS WITH *ICE MAKERS*

Your beverage is only as good as the ice that keeps it cold. Trust Perlick to produce pure ice that lets your cocktails and other beverages shine. Available in clear and cubelet ice styles in both standard and ADA height compliant heights, Perlick indoor/outdoor undercounter ice makers are a must for any well-appointed entertainment space.





CLEAR ICE MAKERS

ICE SHAPE

Rounded, top hat shape

ICE TYPE

Hard, clear, slow melting ice

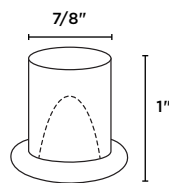

ADVANTAGES

This ice maker produces solid cubes, resulting in clear, slow melting ice that won't dilute your drink as fast as regular ice. The unique shape of each cube isn't just aesthetically pleasing, it also prevents the ice from clumping.

CUBELET ICE MAKERS

ICE SHAPE

Pellet/nugget shape

ICE TYPE

Soft, compacted ice

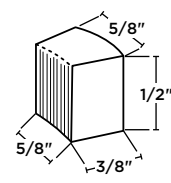

ADVANTAGES

This popular chewable ice absorbs the flavors of the beverages poured over it. It's easy to crunch and is perfect for a wide variety drinks. Cubelet ice is also great for serving specialty foods like seafood.

AVAILABLE MODELS

For complete model number listing, product specs, and quick reference, see page 52.



15" SIGNATURE SERIES ICE MAKERS (Clear or Cubelet)

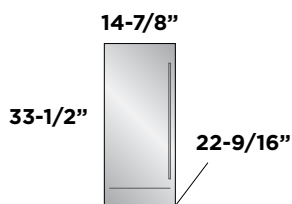

S - Stainless Steel Solid Door
W - Fully Integrated Solid Door *

ADA HEIGHT COMPLIANT SERIES ICE MAKERS (Clear or Cubelet)

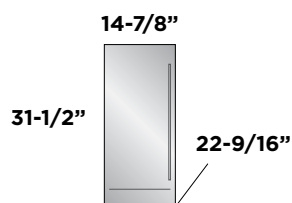

S - Stainless Steel Solid Door
W - Fully Integrated Solid Door *

Photos may vary from actual product.

* This model comes ready to accept a custom panel

ALL THE DELICIOUS DETAILS OF *COLUMN REFRIGERATION*

Perlick's line of column appliances includes 24" and 30" column refrigerators, 24" column freezers, and single- and dual-zone 24" column wine reserves.



(Top left to right) 24" Signature Series Dual-Zone Refrigerator/Wine Reserve, 24" Dual-Zone Wine Column, 24" Column Refrigerator, 24" Column Freezer

COLUMN REFRIGERATOR MODELS

- 24" and 30" column refrigerators feature Perlick's exclusive QuatroCool™ Technology, ensuring precision temperature and humidity control in 4 different regions offering dual chamber air filtration throughout.
- Touch screen controls are customizable to one degree increments in all our columns. Enjoy access to smart settings for a variety of fresh and frozen foods, or store your wines at their ideal temperatures. Access settings for lighting, Sabbath mode, and more with a single touch.
- 24" and 30" column refrigerators feature frameless spill proof shelving, tiered deli drawers, tip out produce bins, and slide in stainless steel pans for marinating or storing premade appetizers and sous vide packets.
- Column refrigerators and freezers are brightly illuminated by white roll-on theatre lighting, while wine columns include the option of white and blue roll-on theatre lighting.
- Wine columns are available in an industry-exclusive single temperature model for maximum capacity or a dual-zone model to store red and white wine at their recommended temperatures.
- Wine columns feature a convertible display shelf to showcase 6 prized wine bottles with additional storage for 4 dessert (half sized) wine bottles when angled up. The shelf easily lays flat to store 11 bottles without additional parts and pieces.
- Perlick's advanced technology monitors humidity levels in our wine reserve and, if necessary, pushes additional moisture into the compartment to maintain 60-70% relative humidity and preserve corks and prevent oxidation. Soft coat full extension shelves gently cradle each bottle and protect them from vibration.
- All columns have stainless steel interiors and exteriors for long life durability, easy cleaning, and sanitation. Manufactured ready to accept custom or stainless steel panels.



30" Column Refrigerator, 24" Column Freezer shown



Tip out produce bin



Open pull out bins (freezer)

COLUMN REFRIGERATORS / FREEZER

AVAILABLE MODELS

For complete model number listing, product specs, and quick reference, see page 54.

24" COLUMN REFRIGERATOR

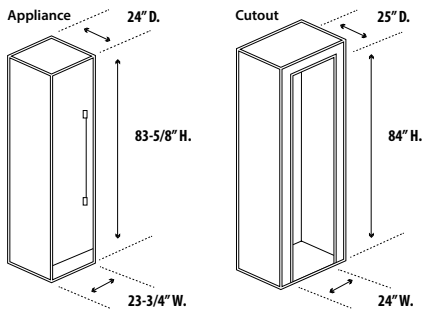

- 1 Stainless Steel Solid Door
- 2 Fully Integrated Solid Doors*

30" COLUMN REFRIGERATOR

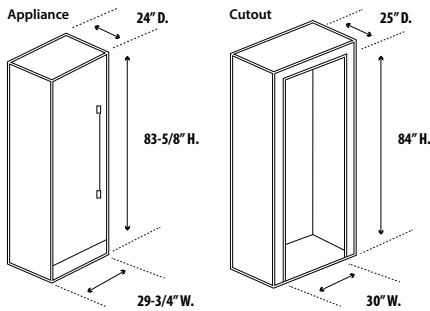

- 1 Stainless Steel Solid Door
- 2 Fully Integrated Solid Doors*

24" COLUMN FREEZER

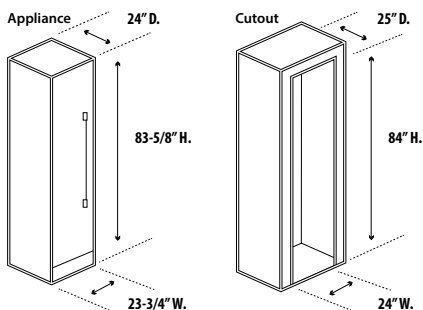

- 1 Stainless Steel Solid Door
- 2 Fully Integrated Solid Doors*



Convertible display shelf



PerIQ™ Touch Screen Control Panel (all columns)

WINE COLUMN REFRIGERATORS

AVAILABLE MODELS

For complete model number listing, product specs, and quick reference, see page 54.

24" COLUMN DUAL-ZONE WINE RESERVE

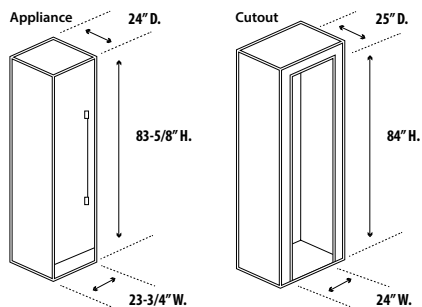

- 4 Stainless Steel Glass Doors
- 4 Fully Integrated Glass Doors*

24" COLUMN SINGLE-ZONE WINE RESERVE

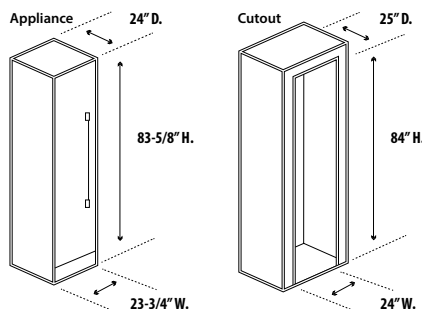

- 4 Stainless Steel Glass Doors
- 4 Fully Integrated Glass Doors*

Photos may vary from actual product.

* This model comes ready to accept a custom panel

ACCESSORIES AND DOOR STYLES

Perlick offers the industry's widest selection of premium undercounter refrigeration for inside and outside the home, and for that, we have a wide selection of accessories and door styles to choose from. Customize your Perlick to meet your exact storing and serving needs.



24" Signature Series Freezer with 24" Martini Rack accessory

SHELVING AND COMPARTMENT ACCESSORIES



RS-15-15R
Shelf, HP15 Refrigerator

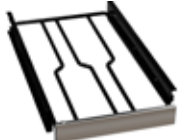

RS-15-15W
Shelf, HP15 Wine



RS-24-24R
Shelf, 24" Refrigerator

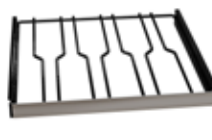

RS-24-24W
Shelf, 24" Wine



RS-24-24M
Shelf, 24" Martini Rack



RS-24-24D
Shelf, 24" Divider



RS-18-18R
Shelf, HH24 Refrigerator



RS-18-18W
Shelf, HH24 Wine



RS-24-24WD
Shelf, 24"
Dual-Zone Wine



65629
Bottle Display Rack



67115-15/67115-24
15" and 24" Wood
Wine Faces



67964
Stainless Steel
Drawer Dividers



DRAWER PAN TRAY RK24DP

Organize fresh and prepared ingredients with Perlick's drawer pan tray. A stainless steel tray holds three stainless steel prep pans that come with stain resistant translucent covers. Available for 24" Signature Series, 24" C-Series and 24" ADA Height Compliant Series Refrigerator Drawer models.

MISC. HARDWARE KITS AND ICE MAKER ACCESSORIES



(L) Factory Installed
Door/Drawer Lock



67439 L/R
Door Hinge Kit



RS-TK-HA24-6 / RS-TK-HH24
6" Toe Kick for ADA
(RS-TK-HA24-6) and Shallow
Depth (RS-TK-HH24)



66736-15/66736
15"/24" Caster Kits



63802A
Drain Pump for
H50 Clear Ice Makers



68117-1
Optional Stainless
Steel Toe Kick for
H50 Ice Makers



STACKING KITS

RS-SK-15L/R / RS-SK-24L/R / RS-SK-18-L/R

Mix and match Perlick undercounter refrigeration to create custom modular refrigeration anywhere inside or outside the home. Choose from refrigerators, freezers, beverage centers and wine reserves, as well as our new dual-zone refrigeration, to create flexible storage for your specific refrigeration needs.

BEER DISPENSER ACCESSORIES



63797

*Beer Dispenser Cleaning Kit
(Includes pump, sanitizer,
and tools to clean lines)*



BLC32 / BLC4
*Sanitizer for
Beer Dispensers
(32 oz / 4 oz)*



308-40C
*Beer Faucet Lock
(Compatible with
630SS Faucets)*



67141-1
*Perlick Beer
Faucet Handle*



630SS
*630SS Forward -
Sealing Faucet*



67782
*Drip Pan for
Beer Dispensers*



LOW PROFILE "S" SERIES KEG COUPLER 40030S

Enjoy a wider variety of kegged beer with the Perlick Low Profile "S" Series Keg Coupler. This coupler fits "S" system kegs, which are used by brands such as **Heineken, Newcastle, Stella Artois, Amstel, Bemish, Murphy's, Strongbow, and Hofbrau** (just to name a few). This coupler can be used on all Perlick beer dispenser models and is exclusive to Perlick.

DOOR STYLES FOR EVERY DESIGN

Stainless Steel Solid Door



1

Fully Integrated Solid Door



2

Stainless Steel Glass Door



3

Fully Integrated Glass Door



4

Stainless Steel Drawers



5

Fully Integrated Drawers



6

Perlick offers a variety of door styles to complement any design. The numbered image above coordinates with the 'Door Styles Available' column in the Quick Reference chart. All doors are available hinged left or right, and fully integrated overlay panels come ready to accept a custom panel from your millworker to create a seamless look with cabinetry.

- Industry-exclusive convertible door design allows all doors to be converted to overlay from stainless steel
- All doors are field reversible with accessory hinge kit (excluding ice maker models)
- Template available to create a matching overlay toe kick



(Left to right) 24" Signature Series Dual-Zone Refrigerator/Freezer Drawers, 24" Signature Series Refrigerator, 24" Signature Series Dual-Zone Wine Reserve, 15" Signature Series Refrigerator Drawers (outdoor)



Intro

signature series

mobile bar/
mobile tap

c-series

ice makers

columns

accessories









quick reference /
model info

(Left to right) 15" Signature Series Beer Dispenser, 24" Signature Series Beverage Center (outdoor)

MODEL SPECIFICATION GUIDE

Model	Type	Page	Description	Overall Dimensions - in. (mm) / Cutout Dimensions - in. (mm)			Shelving (Door Models)	Capacity	Storage Capacity
				Width	Depth	Height			
HP15RS-4-**	Refrigerator	23	15" Signature Series Indoor Refrigerator	14-7/8" (378)	24" (610)	34-1/4" (870)	2 full-extension pullout shelves	2.8 cu.ft.	66 cans
				15" (381)	24-7/8" (632)	34-1/2" (876)			
HP15RS-4-**	Refrigerator	23	15" Signature Series Indoor Refrigerator Drawers	14-7/8" (378)	24" (610)	34-1/4" (870)	No shelves	2.8 cu.ft.	18 cans (Top Drawer)
				15" (381)	24-7/8" (632)	34-1/2" (876)			
HP24RS-4-**	Refrigerator	23	24" Signature Series Indoor Refrigerator	23-7/8" (606)	24" (610)	34-1/4" (870)	2 full-extension pullout shelves	5.2 cu.ft.	144 cans
				24" (610)	24" (610)	34-1/2" (876)			
HP24RS-4-**	Refrigerator	23	24" Signature Series Indoor Refrigerator Drawers	23-7/8" (606)	24" (610)	34-1/4" (870)	No shelves	5.2 cu.ft.	N/A
				24" (610)	24" (610)	34-1/2" (876)			
HH24RS-4-**	Refrigerator	23	18" Signature Shallow Depth Indoor Refrigerator (ADA height compliant)	23-7/8" (606)	18" (457)	32" (813)	2 full-extension pullout shelves	3.1 cu.ft.	68 cans
				24" (610)	18" (457)	32-1/4" (819)			
HP24ZS-4-**	Refrigerator/ Freezer	25	24" Signature Series Indoor Dual-Zone Refrigerator /Freezer Drawers	23-7/8" (606)	24" (610)	34-1/4" (870)	No shelves	5.0 cu.ft.	42 cans (Ref. Drawer)
				24" (610)	24" (610)	34-1/2" (876)			
HP24CS-4-**	Refrigerator/ Wine Reserve	29	24" Signature Series Indoor Dual-Zone Refrigerator/ Wine Reserve	23-7/8" (606)	24" (610)	34-1/4" (870)	2 full-extension wine shelves, 1 full-extension shelf	5.0 cu.ft.	41 cans and 14 bottles of wine
				24" (610)	24" (610)	34-1/2" (876)			
HP24FS-4-**	Freezer	25	24" Signature Series Indoor Freezer	23-7/8" (606)	24" (610)	34-1/4" (870)	2 full-extension pullout shelves	5.2 cu.ft.	N/A
				24" (610)	24" (610)	34-1/2" (876)			
HP24FS-4-**	Freezer	25	24" Signature Series Indoor Freezer Drawers	23-7/8" (606)	24" (610)	34-1/4" (870)	No shelves	5.0 cu.ft.	N/A
				24" (610)	24" (610)	34-1/2" (876)			
HP15BS-4-**	Beverage Center	27	15" Signature Series Indoor Beverage Center	14-7/8" (378)	24" (610)	34-1/4" (870)	2 full-extension wine shelves, 1 full-extension shelf	2.8 cu.ft.	30 cans and 8 bottles of wine
				15" (381)	24-7/8" (632)	34-1/2" (876)			
HP24BS-4-**	Beverage Center	27	24" Signature Series Beverage Center	23-7/8" (606)	24" (610)	34-1/4" (870)	2 full-extension wine shelves, 1 full-extension shelf	5.2 cu.ft.	62 cans and 16 bottles of wine
				24" (610)	24" (610)	34-1/2" (876)			
HH24BS-4-**	Beverage Center	27	18" Signature Shallow Depth Indoor Beverage Center (ADA height compliant)	23-7/8" (606)	18" (457)	32" (813)	2 full-extension wine shelves, 1 full-extension shelf	3.1 cu.ft.	41 cans and 10 bottles of wine
				24" (610)	18" (457)	32-1/4" (819)			
HP15WS-4-**	Wine Reserve	29	15" Signature Series Indoor Wine Reserve	14-7/8" (378)	24" (610)	34-1/4" (870)	5 full-extension wine shelves	2.8 cu.ft.	20 bottles of wine
				15" (381)	24-7/8" (632)	34-1/2" (876)			
HP24WS-4-**	Wine Reserve	29	24" Signature Series Indoor Single-Zone Wine Reserve	23-7/8" (606)	24" (610)	34-1/4" (870)	5 full-extension wine shelves	5.2 cu.ft.	45 bottles of wine
				24" (610)	24" (610)	34-1/2" (876)			
HP24DS-4-**	Wine Reserve	29	24" Signature Series Indoor Dual-Zone Wine Reserve	23-7/8" (606)	24" (610)	34-1/4" (870)	2 (Upper) + 2-1/2 (Lower) full-extension wine shelves	5.2 cu.ft.	32 bottles of wine
				24" (610)	24" (610)	34-1/2" (876)			
HH24WS-4-**	Wine Reserve	29	18" Signature Series Indoor Shallow Depth Wine Reserve (ADA height compliant)	23-7/8" (606)	18" (457)	32" (813)	4 full-extension wine shelves	3.1 cu.ft.	20 bottles of wine
				24" (610)	18" (457)	32-1/4" (819)			
HP15TS-4-**-1*	Beer Dispenser	31	15" Signature Series Indoor Beer Dispenser	14-7/8" (378)	24" (610)	34-1/4" (870)	No shelves	2.8 cu.ft.	(1) 1/6 barrel
				15" (381)	24-7/8" (632)	34-1/2" (876)			
HP15TS-4-**-1A*	Beer Dispenser	31	15" Signature Series Indoor Adara Beer Dispenser	14-7/8" (606)	24" (610)	34-1/4" (870)	No shelves	2.8 cu.ft.	(1) 1/6 barrel
				15" (610)	24-7/8" (632)	34-1/2" (876)			
HP24TS-4-**-1*	Beer Dispenser	31	24" Signature Series Indoor Beer Dispenser - Single Tap	23-7/8" (606)	24" (610)	34-1/4" (870)	No shelves	5.2 cu.ft.	(2) 1/6 barrels or (1) 1/4 slim or standard barrel
				24" (610)	24" (610)	34-1/2" (876)			
HP24TS-4-**-2*	Beer Dispenser	31	24" Signature Series Indoor Beer Dispenser - Two Tap	23-7/8" (606)	24" (610)	34-1/4" (870)	No shelves	5.2 cu.ft.	(2) 1/6 barrels or (1) 1/4 slim or standard barrel
				24" (610)	24" (610)	34-1/2" (876)			
HP24TS-4-**-1A*	Beer Dispenser	31	24" Signature Series Indoor Adara Beer Dispenser - Single Tap	23-7/8" (606)	24" (610)	34-1/4" (870)	No shelves	5.2 cu.ft.	(2) 1/6 barrels or (1) 1/4 slim or standard barrel
				24" (610)	24" (610)	34-1/2" (876)			
HP24TS-4-**-2A*	Beer Dispenser	31	24" Signature Series Indoor Adara Beer Dispenser - Two Tap	23-7/8" (606)	24" (610)	34-1/4" (870)	No shelves	5.2 cu.ft.	(2) 1/6 barrels or (1) 1/4 slim or standard barrel
				24" (610)	24" (610)	34-1/2" (876)			

SIGNATURE SERIES

Temp. Range °F(°C)	Power Requirements	Refrigerant	LED Lighting Options	K Level	Door Styles	Outdoor Model Number	Marine Model Number	Warranty	Industry Exclusive	Energy Star
33°(5°) - 48°(8.8°)	115 VAC/60 Hz/1 Ph	R600a (38g)	Cool blue or crisp white	6000K	1,2,3,4	HP15RO-4-**	HP15RM-4-**	Full 6 Year		
33°(5°) - 48°(8.8°)	115 VAC/60 Hz/1 Ph	R600a (38g)	White LED task lighting	6000K	5,6	HP15RO-4-**	HP15RM-4-**	Full 6 Year	•	
33°(5°) - 48°(8.8°)	115 VAC/60 Hz/1 Ph	R600a (50g)	Cool blue or crisp white	6000K	1,2,3,4	HP24RO-4-**	HP24RM-4-**	Full 6 Year		
33°(5°) - 48°(8.8°)	115 VAC/60 Hz/1 Ph	R600a (50g)	White LED task lighting	6000K	5,6	HP24RO-4-**	HP24RM-4-**	Full 6 Year		
33°(5°) - 48°(8.8°)	115 VAC/60 Hz/1 Ph	R600a (50g)	Cool blue or crisp white	6000K	1,2,3,4	HH24RO-4-**	HH24RM-4-**	Full 6 Year	•	
Lower (-10°-10°) / Upper 30°-42°)	115 VAC/60 Hz/1 Ph	R600a (50g)	White LED task lighting	6000K	5,6	HP24ZO-4-**	HP24ZM-4-**	Full 6 Year	•	
Lower (33° - 42°F) / Upper (45° - 65°F)	115 VAC/60 Hz/1 Ph	R600a (57g)	Cool blue or crisp white	6000K	1,2,3,4	HP24CO-4-**	HP24CM-4-**	Full 6 Year	•	
-10° (-23.3°) - 10° (-12.2°)	115 VAC/60 Hz/1 Ph	R600a (57g)	White LED task lighting	6000K	1,2,5,6	HP24FO-4-**	HP24FM-4-**	Full 6 Year		
-10° (-23.3°) - 10° (-12.2°)	115 VAC/60 Hz/1 Ph	R600a (57g)	White LED task lighting	6000K	5,6	HP24FO-4-**	HP24FM-4-**	Full 6 Year		
33°(5°) - 48°(8.8°)	115 VAC/60 Hz/1 Ph	R600a (38g)	Cool blue or crisp white	6000K	1,2,3,4,5,6	HP15BO-4-**	HP15BM-4-**	Full 6 Year	•	
33°(5°) - 48°(8.8°)	115 VAC/60 Hz/1 Ph	R600a (50g)	Cool blue or crisp white	6000K	1,2,3,4	HP24BO-4-**	HP24BM-4-**	Full 6 Year		
33°(5°) - 48°(8.8°)	115 VAC/60 Hz/1 Ph	R600a (50g)	Cool blue or crisp white	6000K	1,2,3,4	HH24BO-4-**	HH24BM-4-**	Full 6 Year	•	
45° (7.2°) - 65° (18.33°)	115 VAC/60 Hz/1 Ph	R600a (38g)	Cool blue or crisp white	6000K	1,2,3,4	HP15WO-4-**	HP15WM-4-**	Full 6 Year		
45° (7.2°) - 65° (18.3°)	115 VAC/60 Hz/1 Ph	R600a (50g)	Cool blue or crisp white	6000K	1,2,3,4	HP24WO-4-**	HP24WM-4-**	Full 6 Year		
45°/ 51° (7.2°/ 10.5°) - 55°/ 65° (12.7°/ 18.3°)	115 VAC/60 Hz/1 Ph	R600a (45g)	Cool blue or crisp white	6000K	1,2,3,4	HP24DO-4-**	HP24DM-4-**	Full 6 Year		
45° (7.2°) - 65° (18.3°)	115 VAC/60 Hz/1 Ph	R600a (50g)	Cool blue or crisp white	6000K	1,2,3,4	HH24WO-4-**	HH24WM-4-**	Full 6 Year	•	
33°(5°) - 48°(8.8°)	115 VAC/60 Hz/1 Ph	R600a (38g)	White LED task lighting	6000K	1,2	HP15TO-4-**-1*	HP15TM-4-**-1*	Full 6 Year		
33°(5°) - 48°(8.8°)	115 VAC/60 Hz/1 Ph	R600a (38g)	White LED task lighting	6000K	1,2	N/A	N/A	Full 6 Year	•	
33°(5°) - 48°(8.8°)	115 VAC/60 Hz/1 Ph	R600a (50g)	White LED task lighting	6000K	1,2	HP24TO-4-**-1*	HP24TM-4-**-1*	Full 6 Year		
33°(5°) - 48°(8.8°)	115 VAC/60 Hz/1 Ph	R600a (50g)	White LED task lighting	6000K	1,2	HP24TO-4-**-2*	HP24TM-4-**-2*	Full 6 Year		
33°(5°) - 48°(8.8°)	115 VAC/60 Hz/1 Ph	R600a (50g)	White LED task lighting	6000K	1,2	N/A	N/A	Full 6 Year	•	
33°(5°) - 48°(8.8°)	115 VAC/60 Hz/1 Ph	R600a (50g)	White LED task lighting	6000K	1,2	N/A	N/A	Full 6 Year	•	

DOOR STYLE GUIDE:

1) Stainless Steel Solid Door 2) Fully Integrated Solid Door 3) Stainless Steel Glass Door 4) Fully Integrated Glass Door 5) Stainless Steel Drawers
6) Fully Integrated Drawers

MODEL SPECIFICATION GUIDE

				Overall Dimensions - in. (mm) / Cutout Dimensions - in. (mm)			Shelving (Door Models)	Capacity	Storage Capacity	
	Model	Type	Page	Description	Width	Depth				Height
C-SERIES	HC24RB-4**	Refrigerator	34	24" C-Series Indoor Refrigerator	23-7/8" (606) 24" (610)	24" (610)	34-1/4" (870) 34-1/2" (876)	2 full-extension pullout shelves	5.2 cu.ft.	144 cans (Door Model)
	HC24RB-4**	Refrigerator	34	24" C-Series Indoor Refrigerator Drawers	23-7/8" (606) 24" (610)	24" (610)	34-1/4" (870) 34-1/2" (876)	No shelves	5.2 cu.ft.	N/A
	HC24BB-4**	Beverage Center	34	24" C-Series Indoor Beverage Center	23-7/8" (606) 24" (610)	24" (610)	34-1/4" (870) 34-1/2" (876)	2 full-extension wine shelves, 1 full-extension shelf	5.2 cu.ft.	62 cans and 16 bottles of wine
	HC24WB-4**	Wine Reserve	34	24" C-Series Indoor Wine Reserve	23-7/8" (606) 24" (610)	24" (610)	34-1/4" (870) 34-1/2" (876)	5 full-extension wine shelves	5.2 cu.ft.	45 bottles of wine
	HC24TB-4**	Beer Dispenser	34	24" C-Series Indoor Beer Dispenser Single or Two Faucet	23-7/8" (606) 24" (610)	24" (610)	34-1/4" (870) 34-1/2" (876)	No shelves	5.2 cu.ft.	(2) 1/6 barrels or (1) 1/4 slim or standard barrel

				Overall Dimensions - in. (mm) / Cutout Dimensions - in. (mm)			Shelving (Door Models)	Capacity	Storage Capacity	
	Model	Type	Page	Description	Width	Depth				Height
ADA HEIGHT COMPLIANT SERIES	HA24RB-4**	Refrigerator	35	ADA Height Compliant Indoor Refrigerator	23-7/8" (606) 24" (610)	24" (610) 24-7/8" (632)	32" (813) 32-1/4" (819)	2 full-extension pullout shelves	4.8 cu.ft.	108 cans
	HA24RB-4**	Refrigerator	35	ADA Height Compliant Indoor Refrigerator Drawers	23-7/8" (606) 24" (610)	24" (610) 24-7/8" (632)	32" (813) 32-1/4" (819)	No shelves	4.8 cu.ft.	N/A
	HA24FB-4**	Freezer	35	ADA Height Compliant Indoor Freezer	23-7/8" (606) 24" (610)	24" (610) 24-7/8" (632)	32" (813) 32-1/4" (819)	2 full-extension pullout shelves	4.8 cu.ft.	N/A
	HA24FB-4**	Freezer	35	ADA Height Compliant Indoor Freezer Drawers	23-7/8" (606) 24" (610)	24" (610) 24-7/8" (632)	32" (813) 32-1/4" (819)	No shelves	4.6 cu.ft.	N/A
	HA24BB-4**	Beverage Center	35	ADA Height Compliant Indoor Beverage Center	23-7/8" (606) 24" (610)	24" (610) 24-7/8" (632)	32" (813) 32-1/4" (819)	2 full-extension wine shelves, 1 full-extension shelf	4.8 cu.ft.	62 cans and 16 bottles of wine
	HA24WB-4**	Wine Reserve	35	ADA Height Compliant Indoor Wine Reserve	23-7/8" (606) 24" (610)	24" (610) 24-7/8" (632)	32" (813) 32-1/4" (819)	4 full-extension wine shelves	4.8 cu.ft.	32 bottles of wine

				Overall Dimensions - in. (mm) / Cutout Dimensions - in. (mm)			Shelving (Door Models)	Capacity	Storage Capacity	
	Model	Type	Page	Description	Width	Depth				Height
ICE MAKERS	H50IMS-*	Ice Maker	37	15" Signature Series Clear Ice Maker, hinge reversible	14-7/8" (378) 15" (381)	22-9/16" (573) 23" (584)	33-1/2" (851) 34" (864)	N/A	51lbs.	22lbs.
	H50IMW*	Ice Maker	37	15" Signature Series Clear Ice Maker, panel-ready, hinge reversible	14-7/8" (378) 15" (381)	22-9/16" (573) 23" (584)	33-1/2" (851) 34" (864)	N/A	51lbs.	22lbs.
	H50IMS-AD*	Ice Maker	37	15" ADA Height Compliant Signature Series Clear Ice Maker, hinge reversible	14-7/8" (378) 15" (381)	22-9/16" (573) 23" (584)	33-1/2" (851) 34" (864)	N/A	51lbs.	22lbs.
	H50IMW-AD*	Ice Maker	37	15" ADA Height Compliant Signature Series Clear Ice Maker, panel-ready, hinge reversible	14-7/8" (378) 15" (381)	22-9/16" (573) 23" (584)	33-1/2" (851) 34" (864)	N/A	51lbs.	22lbs.
	H80CIMS-*	Ice Maker	37	15" Signature Series Cubelet Ice Maker, hinge reversible	14-7/8" (378) 15" (381)	22-9/16" (573) 23" (584)	33-1/2" (851) 34" (864)	N/A	80lbs.	22lbs.
	H80CIMW*	Ice Maker	37	15" Signature Series Cubelet Ice Maker, panel-ready, hinge reversible	14-7/8" (378) 15" (381)	22-9/16" (573) 23" (584)	33-1/2" (851) 34" (864)	N/A	80lbs.	22lbs.
	H80CIMS-AD*	Ice Maker	37	15" ADA Height Compliant Signature Series Cubelet Ice Maker, hinge reversible	14-7/8" (378) 15" (381)	22-9/16" (573) 23" (584)	33-1/2" (851) 34" (864)	N/A	80lbs.	22lbs.
	H80CIMW-AD*	Ice Maker	37	15" ADA Height Compliant Signature Series Cubelet Ice Maker, panel-ready, hinge reversible	14-7/8" (378) 15" (381)	22-9/16" (573) 23" (584)	33-1/2" (851) 34" (864)	N/A	80lbs.	22lbs.

Temp. Range °F(°C)	Power Requirements	Refrigerant	LED Lighting Options	K Level	Door Styles	Outdoor Model Number	Warranty	Industry Exclusive	Energy Star
33°(5°) - 48°(8.8°)	115 VAC/60 Hz/1 Ph	R600a (50g)	Cool blue or crisp white	6000K	1,2,3,4	HC24RO-4-***	Full 6 Year		
33°(5°) - 48°(8.8°)	115 VAC/60 Hz/1 Ph	R600a (50g)	White LED task lighting	6000K	5,6	HC24RO-4-***	Full 6 Year		
33°(5°) - 48°(8.8°)	115 VAC/60 Hz/1 Ph	R600a (50g)	Cool blue or crisp white	6000K	1,2,3,4	N/A	Full 6 Year		
45°(7.2°) - 65°(18.3°)	115 VAC/60 Hz/1 Ph	R600a (50g)	Cool blue or crisp white	6000K	1,2,3,4	N/A	Full 6 Year		
33°(5°) - 48°(8.8°)	115 VAC/60 Hz/1 Ph	R600a (50g)	Cool blue or crisp white	6000K	1,2	HC24TO-4-***	Full 6 Year		

Temp. Range °F(°C)	Power Requirements	Refrigerant	LED Lighting Options	K Level	Door Styles	Outdoor Model Number	Warranty	Industry Exclusive	Energy Star
33°(5°) - 48°(8.8°)	115 VAC/60 Hz/1 Ph	R600a (50g)	Cool blue or crisp white	6000K	1,2,3,4	N/A	Full 6 Year		
33°(5°) - 48°(8.8°)	115 VAC/60 Hz/1 Ph	R600a (50g)	White LED task lighting	6000K	5,6	N/A	Full 6 Year		
-10°(-23.3°) - 10°(-12.2°)	115 VAC/60 Hz/1 Ph	R600a (57g)	White LED task lighting	6000K	1,2	N/A	Full 6 Year	•	
-10°(-23.3°) - 10°(-12.2°)	115 VAC/60 Hz/1 Ph	R600a (57g)	White LED task lighting	6000K	5,6	N/A	Full 6 Year		
33°(5°) - 48°(8.8°)	115 VAC/60 Hz/1 Ph	R600a (50g)	Cool blue or crisp white	6000K	1,2,3,4	N/A	Full 6 Year		
45°(7.2°) - 65°(18.3°)	115 VAC/60 Hz/1 Ph	R600a (50g)	Cool blue or crisp white	6000K	1,2,3,4	N/A	Full 6 Year		

Ambient Temp. Range °F(°C)	Water Temp. Range °F(°C)	Water Pressure	Power Requirements	Refrigerant	Door Styles	Outdoor Model Number	Warranty	Industry Exclusive	Energy Star
45°(7.2°) - 100°(37.8°)	45°(7.2°) - 90°(32.2°)	7-113 psig	115 VAC/60 Hz/1 Ph	R600a (50g)	1	Same	Full 2 Year		
45°(7.2°) - 100°(37.8°)	45°(7.2°) - 90°(32.2°)	7-113 psig	115 VAC/60 Hz/1 Ph	R600a (50g)	2	Same	Full 2 Year		
45°(7.2°) - 100°(37.8°)	45°(7.2°) - 90°(32.2°)	7-113 psig	115 VAC/60 Hz/1 Ph	R600a (57g)	1	Same	Full 2 Year		
45°(7.2°) - 100°(37.8°)	45°(7.2°) - 90°(32.2°)	7-113 psig	115 VAC/60 Hz/1 Ph	R600a (57g)	2	Same	Full 2 Year		
45°(7.2°) - 100°(37.8°)	45°(7.2°) - 90°(32.2°)	7-113 psig	115 VAC/60 Hz/1 Ph	R600a (50g)	1	Same	Full 2 Year		
45°(7.2°) - 100°(37.8°)	45°(7.2°) - 90°(32.2°)	7-113 psig	115 VAC/60 Hz/1 Ph	R600a (50g)	2	Same	Full 2 Year		
45°(7.2°) - 100°(37.8°)	45°(7.2°) - 90°(32.2°)	7-113 psig	115 VAC/60 Hz/1 Ph	R600a (50g)	1	Same	Full 2 Year		
45°(7.2°) - 100°(37.8°)	45°(7.2°) - 90°(32.2°)	7-113 psig	115 VAC/60 Hz/1 Ph	R600a (50g)	2	Same	Full 2 Year		

DOOR STYLE GUIDE:

1) Stainless Steel Solid Door 2) Fully Integrated Solid Door 3) Stainless Steel Glass Door 4) Fully Integrated Glass Door 5) Stainless Steel Drawers
6) Fully Integrated Drawers

MODEL SPECIFICATION GUIDE

Model	Type	Page	Description	Appliance Exterior Dimensions - in. (mm) / Cutout Dimensions - in. (mm)			Shelving (Door Models)	Capacity	Storage Capacity
				Width	Depth	Height			
CR24R-1-2*	24" Column Refrigerator	40	All Refrigerator, hinge reversible	23-3/4" (603)	24" (610)	83-5/8" (2125)	3 adjustable height spill-proof shelves Deli drawer Meat drawer 1 marinating pan Tip out produce bin 4 door bins	12.8 cu.ft.	N/A
				24" (610)	25" (635)	84" (2134)			
CR30R-1-2*	30" Column Refrigerator	40	All Refrigerator, hinge reversible	29-3/4" (756)	24" (610)	83-5/8" (2125)	3 adjustable height spill-proof shelves Deli drawer Meatdrawer 2 marinating pans Tip out produce bin 4 door bins	16.6 cu.ft.	N/A
				30" (762)	25" (635)	84" (2134)			
CR24F-1-2*	24" Column Freezer	40	All Freezer, hinge reversible	23-3/4" (603)	24" (610)	83-5/8" (2125)	3 adjustable height shelves 3 pull-out bins 4 door bins	12.6 cu.ft.	N/A
				24" (610)	25" (635)	84" (2134)			
CR24W-1-2*	24" Wine Reserve	41	Single-zone wine reserve, hinge reversible	23-3/4" (603)	24" (610)	83-5/8" (2125)	12 full-extension wine shelves including one convertible display shelf	12.6 cu.ft.	94 750 mL bottles (99 bottles if you double stack the display shelf)
				24" (610)	25" (635)	84" (2134)			
CR24D-1-2*	24" Wine Reserve	41	Dual-zone wine reserve, hinge reversible	23-3/4" (603)	24" (610)	83-5/8" (2125)	10 full-extension wine shelves including one convertible display shelf	12.2 cu.ft.	86 750 mL bottles (91 bottles if you double stack the display shelf)
				24" (610)	25" (635)	84" (2134)			

COLUMNS

ROUGH CUTOUT DIMENSIONS

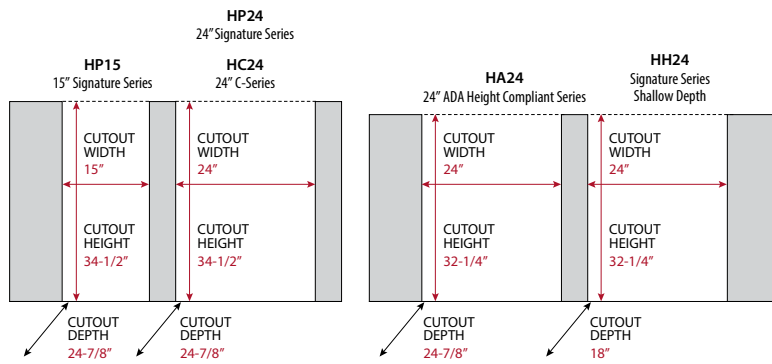

* For all HP, HC, and HA models. To achieve 24" installation depth, install electrical connection in adjacent cabinetry. See spec sheets and installation instructions for install instructions.

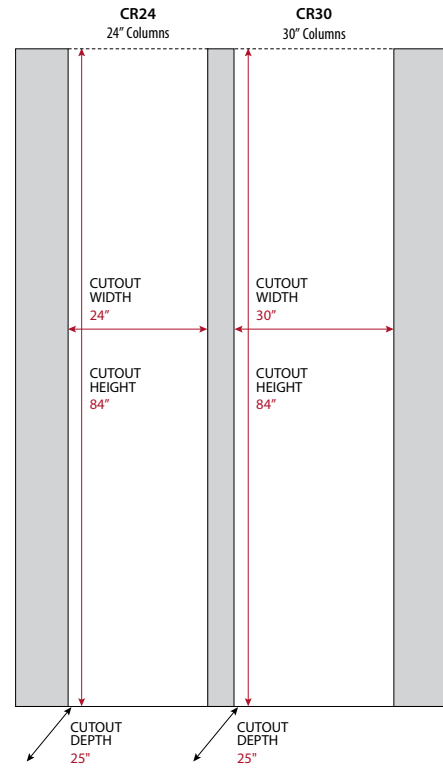

* HH24 models have a recessed plug for a true 18" depth

Temp. Range °F(°C)	Power Requirements	Refrigerant	LED Lighting Options	K Level	Door Styles	Outdoor Model Number	Warranty	Industry Exclusive	Energy Star
Main Compartment - 34°(1.1°) - 42°(5.6°) Deli Drawer - 32°(0°) - 37°(2.8°) Meat/Fish Drawer - 32°(0°) - 37°(2.8°) Tip out Produce Bin - 32°(0°) - 37°(2.8°)	115 VAC/60 Hz/2.3 Amps	R600a (50g)	White roll-on theater lighting	4000K	1,2	N/A	Full 6 Year		
Main Compartment - 34°(1.1°) - 42°(5.6°) Deli Drawer - 32°(0°) - 37°(2.8°) Meat/Fish Drawer - 32°(0°) - 37°(2.8°) Tip out Produce Bin - 32°(0°) - 37°(2.8°)	115 VAC/60 Hz/2.3 Amps	R600a (50g)	White roll-on theater lighting	4000K	1,2	N/A	Full 6 Year		
-10°(-23.3°) - 10°(-12.2°)	115 VAC/60 Hz/2.3 Amps	R600a (50g)	White roll-on theater lighting	4000K	1,2	N/A	Full 6 Year		
40°(4.4°) - 68°(20°)	115 VAC/60 Hz/2.3 Amps	R600a (50g)	White and blue roll-on theater lighting including Sabbath Mode	4000K	1,2,3,4	N/A	Full 6 Year		
Upper Zone - 40°(4.4°) - 68°(20°) Lower Zone - 40°(4.4°) - 68°(20°)**	115 VAC/60 Hz/2.3 Amps	R600a (50g)	White and blue roll-on theater lighting including Sabbath Mode	4000K	1,2,3,4	N/A	Full 6 Year		

DOOR STYLE GUIDE:





- 1) Stainless Steel Solid Door 2) Fully Integrated Solid Door 3) Stainless Steel Glass Door 4) Fully Integrated Glass Door 5) Stainless Steel Drawers
6) Fully Integrated Drawers

MODEL SPECIFICATION GUIDE

					Overall Dimensions - in. (mm)					
	Model	Type	Page	Description	Length	Width	Height	Ice Chest	Insulated Bottle Well	Drainboard
MOBILE BARS	RMB-001	Mobile Bar	34	Tobin Ellis Signature Series Limited Edition Mobile Bar	70" (1778)	34-1/2" (877)	43-3/4" (1112)	TS30IC with sliding cover	TSC12IBW	TSCS12 (2 ea.)
	RMB-002	Mobile Bar	34	70" Tobin Ellis Signature Series Mobile Bar with drainboard and sink configuration	70-1/8" (1785)	35-9/16" (903)	46-5/16" (1176)	TS30IC with sliding cover	TSC12IBW	TSCS12 (1 ea.)
	RMB-003	Mobile Bar	34	70" Tobin Ellis Signature Series Mobile Bar with 2 drainboards	70-1/8" (1785)	35-9/16" (903)	34-1/4" (870) 34-1/2" (876)	TS30IC with sliding cover	TSC12IBW	TSCS12 (2 ea.)
	RMB-004	Mobile Bar	34	46" Tobin Ellis Signature Series Mobile Bar	46-1/4" (1175)	35-9/16" (903)	46-5/16" (1176)	TS30IC with sliding cover	TSC12IBW	N/A

					Overall Dimensions - in. (mm) / Cutout Dimensions - in. (mm)					
	Model	Type	Page	Description	Length	Width	Height	Shelving (Door Models)	Capacity	Storage Capacity
MOBILE TAP	HP24TS-4-1L-2MNC	Mobile Tap	34	Mobile Tap Nitro and Coffee or Wine	23-7/8" (606)	24" (610)	34-1/4" (870)	No shelves	5.2 cu.ft.	(2) 1/6 barrels or (1) 1/4 slim or standard barrel
					24" (610)	24" (610)	34-1/2" (876)			
	HP24TS-4-1L-2MWW	Mobile Tap	34	Mobile Tap Wine	23-7/8" (606)	24" (610)	34-1/4" (870)	No shelves	5.2 cu.ft.	(2) 1/6 barrels or (1) 1/4 slim or standard barrel
					24" (610)	24" (610)	34-1/2" (876)			
	HP24TS-4-1L-2MBW	Mobile Tap	34	Mobile Tap Beer	23-7/8" (606)	24" (610)	34-1/4" (870)	No shelves	5.2 cu.ft.	(2) 1/6 barrels or (1) 1/4 slim or standard barrel
					24" (610)	24" (610)	34-1/2" (876)			
	HP24TS-4-1L-2MBB	Mobile Tap	34	Mobile Tap Beer and Wine	23-7/8" (606)	24" (610)	34-1/4" (870)	No shelves	5.2 cu.ft.	(2) 1/6 barrels or (1) 1/4 slim or standard barrel
					24" (610)	24" (610)	34-1/2" (876)			

Hand Sink	Speed Rail	Electrical	LED Bartender Task Lighting	Water Heater	Water Heater Tank Volume	Water Pump	Gray Water/ Ice Melt Tank (Pre-Plumbed) Capacity	Potable Water Tank (Pre-Plumbed) Capacity	Exterior Materials
N/A	SRC-CL left curved (1 ea.) SRC-CR right curved (1 ea.) SRC-S18 18" straight (1 ea.)	Voltage 120V AC/ Frequency 60 Hz	4000K/ 1200 LM	N/A	N/A	N/A	(2) 2.5gal	N/A	Toffee Crocodile exterior/Vanilla Sugar engineered solid surface top
TS12HSN with side splash	SRC-CL left curved (1 ea.) SRC-CR right curved (1 ea.) SRC-S18 18" straight (1 ea.)	Voltage 120V AC/ Frequency 60 Hz	4000K/ 1200 LM	50°F - 140°F (10°C - 60°C)	1.5 gal (5.7 L)	3 GPM (11.3 LPM)	(1) 2.5gal and (1) 6gal	5 gal (18.9 L)	Black laminate exterior/White Quartz engineered solid surface top
N/A	SRC-CL left curved (1 ea.) SRC-CR right curved (1 ea.) SRC-S18 18" straight (1 ea.)	Voltage 120V AC/ Frequency 60 Hz	4000K/ 1200 LM	N/A	N/A	N/A	(2) 2.5gal	N/A	Black laminate exterior/White Quartz engineered solid surface top
N/A	SRC-CL left curved (1 ea.) SRC-CR right curved (1 ea.) SRC-S18 18" straight (1 ea.)	Voltage 120V AC/ Frequency 60 Hz	4000K/ 800 LM	N/A	N/A	N/A	(1) 2.5gal	N/A	Black laminate exterior/White Quartz engineered solid surface top

Temp. Range °F(°C)	Power Requirements	Refrigerant	LED Lighting Options	K Level	Door Styles	Outdoor Model Number	Marine Model Number	Warranty	Industry Exclusive	Energy Star
33°(.5°) - 48°(8.8°)	115 VAC/60 Hz/1 Ph	R600a (50g)	White LED task lighting	6000K	1,2	HP24TO-4-**-1*	HP24TM-4-**-1*	Full 6 Year		
33°(.5°) - 48°(8.8°)	115 VAC/60 Hz/1 Ph	R600a (50g)	White LED task lighting	6000K	1,2	HP24TO-4-**-1*	HP24TM-4-**-1*	Full 6 Year		
33°(.5°) - 48°(8.8°)	115 VAC/60 Hz/1 Ph	R600a (50g)	White LED task lighting	6000K	1,2	HP24TO-4-**-1*	HP24TM-4-**-1*	Full 6 Year		
33°(.5°) - 48°(8.8°)	115 VAC/60 Hz/1 Ph	R600a (50g)	White LED task lighting	6000K	1,2	HP24TO-4-**-1*	HP24TM-4-**-1*	Full 6 Year		





(Left to right) 24" Signature Series Dual-Zone Refrigerator/Freezer Drawers, 24" Signature Series Dual-Zone Wine Reserve/Wine Reserve, 24" Signature Series Beverage Center



8300 WEST GOOD HOPE ROAD | MILWAUKEE, WI 53223
800.558.5592 | [PERLICK.COM](https://www.perlick.com)

